

NSH SERIES CONNECTOR

NSH Series couplings are general purpose versions of our pressure-balanced, non-spill, ChemQuik® CQG06 couplings. Molded polypropylene, EPDM seals and a 100% springless and metal-free flow path provide broad chemical resistance and exceptionally high flow capacity, allowing instant disconnects (and reconnects), even under pressure. Their non-spill design virtually eliminates spills and minimizes downtime in a very low cost package.



SPECIFICATIONS

PRESSURE:

Vacuum to 120 psi, 8.3 bar

TEMPERATURE:

32°F to 120°F (0°C to 49°C)

MATERIALS:

Main components: Glass-filled polypropylene

Thumb latch: Glass-filled polypropylene

O-rings: EPDM

Springs (non-wetted): 316 stainless steel

Compression nuts: White polypropylene

COLOR:

Gray with dark gray accent standard; red or blue thumb latch and insert tip available.

TUBING SIZES:

3/8" to 3/4" ID, 9.5mm to 19.0mm ID

LUBRICANTS: Krytox® PFPE (inert)

SPILLAGE: 0.03 cc/connect

INCLUSION: 0.42 cc per connect

PANEL MOUNT:

Optional adaptor kit (see page 89)

WARNING: Pressure, temperature, chemicals, and operating environment can affect the performance of couplings. It is the customer's responsibility to test the suitability of CPC products in their own application conditions. Use the graphs below as a guide.

Compatible with ChemQuik® Dual Containment System; DrumQuik® Universal Dispense System and Asian Drum Adaptors.

FEATURES

Non-spill design

Pressure-balanced design

Springless flow path design

Optional color coding

BENEFITS

Ultimate protection from chemicals and fumes

Failsafe disconnect, even under pressure; easy to reconnect at high pressure

Eliminates source of metallic contaminants

Helps prevent accidental misconnects

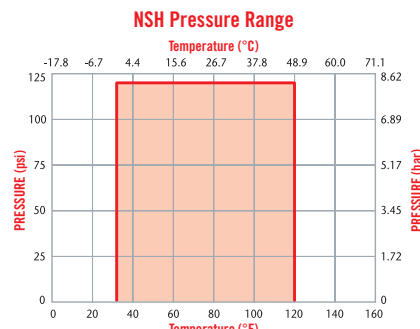
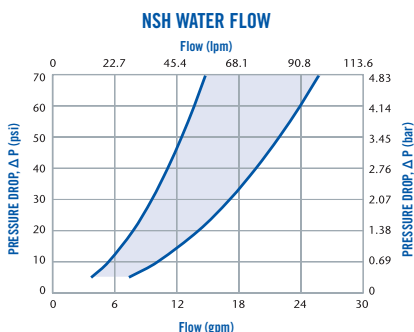

These graphs are intended to give you a general idea of the performance capabilities of each product line. The shaded area of each graph represents the operating range of the product family, i.e., upper and lower values are shown. Therefore, depending on the exact coupling configurations selected, you can reasonably expect values to fall within the shaded area.



SCAN

cpcworldwide.com/NSH





COLDER PRODUCTS COMPANY
U.S.A.
PHONE: +1 (651) 645-0091
FAX: +1 (651) 645-5404
TOLL FREE: +1 (800) 444-2474
E-MAIL: info@cpcworldwide.com

COLDER PRODUCTS COMPANY GMBH
Germany
E-MAIL: cpcgmbh@cpcworldwide.com



DOVER (SHANGHAI) INDUSTRIAL CO., LTD
ShangHai, China
PHONE: +86 21 2411 2666
TOLL FREE: +86 400 990 1978
E-MAIL: asiapacific@cpcworldwide.com

NSH SERIES DIMENSIONS

COUPLING BODIES - Polypropylene

TERMINATION	TUBING/THREAD SIZE	METRIC EQ.	SHUTOFF	A	B
 IN-LINE PIPE THREAD	3/8" FEMALE NPT		NSHD19006	2 (50.8)	3.70
	1/2" NPT		NSHD10008	2 (50.8)	3.81
	3/4" NPT		NSHD10012	2 (50.8)	4.01
 IN-LINE COMPRESSION	3/8" OD	9.5mm OD	NSHD13006	2 (50.8)	3.97
	1/2" OD	12.7mm OD	NSHD13008	2 (50.8)	4.10
 IN-LINE HOSE BARB	3/8" ID	9.5mm ID	NSHD17006	2 (50.8)	3.73
	1/2" ID	12.7mm ID	NSHD17008	2 (50.8)	3.73
	5/8" ID	15.9mm ID	NSHD17010	2 (50.8)	3.88
	3/4" ID	19.0mm ID	NSHD17012	2 (50.8)	3.88

COUPLING INSERTS - Polypropylene

TERMINATION	TUBING/THREAD SIZE	METRIC EQ.	SHUTOFF	A	B
 IN-LINE PIPE THREAD	3/8" FEMALE NPT		NSHD26006	1.64 (41.7)	3.87 (98.3)
	3/8" BSPT		NSHD24006BSPT	1.64 (41.7)	3.84 (97.5)
	1/2" NPT		NSHD24008	1.64 (41.7)	3.98 (101.1)
	3/4" NPT		NSHD24012	1.64 (41.7)	3.98 (101.1)
 IN-LINE COMPRESSION	3/8" OD	9.5mm OD	NSHD20006	1.64 (41.7)	4.14 (105.2)
	1/2" OD	12.7mm OD	NSHD20008	1.64 (41.7)	4.27 (108.5)
 IN-LINE HOSE BARB	3/8" ID	9.5mm ID	NSHD22006	1.64 (41.7)	3.9 (99.1)
	1/2" ID	12.7mm ID	NSHD22008	1.64 (41.7)	3.9 (99.1)
	5/8" ID	15.9mm ID	NSHD22010	1.64 (41.7)	4.05 (102.9)
	3/4" ID	19.0mm ID	NSHD22012	1.64 (41.7)	4.05 (102.9)

All measurements are in inches (millimeters) unless otherwise noted. Tubing must meet stated inside and outside diameters. *Panel mount kit can be used with body for front mount or insert for front or rear mount.

ACCESSORIES



DESCRIPTION	PART NO.
PANEL MOUNT KIT: WITH PANEL SEAL DUST PLUG/CAP FOR BODY OR INSERT*	NSHPMKIT12
	1800700 (not shown)

PRODUCT DIMENSIONS

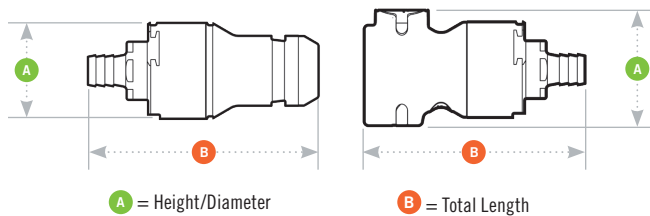

PANEL DIMENSIONS

	PANEL OPENING	PANEL THICKNESS MAX.—MIN.
COUPLING INSERTS	see drawing	0.50 — 0.12

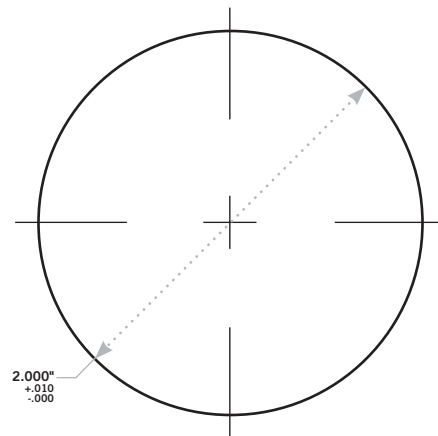

WARRANTY: All sales are subject to Colder Products Company's limited express warranty set forth in the CPC catalog. Contact your local distributor or CPC Customer Service for warranty provisions.

Warning: Due to the wide variety of possible fluid media and operating conditions, unintended consequences may result from the use of this product, all of which are beyond the control of CPC. It is the user's responsibility to carefully determine and test for compatibility for use with their application. All such risks shall be assumed by the buyer.

COPYRIGHT © 2021 BY COLDER PRODUCTS COMPANY. COLDER PRODUCTS COMPANY, COLDER PRODUCTS AND CPC ARE REGISTERED

TRADEMARKS WITH THE US PATENT & TRADEMARK OFFICE