



CONNECTION SOLUTIONS FOR BIOPHARMACEUTICAL PROCESSES





WE INSPIRE CONFIDENCE AT EVERY POINT OF CONNECTION

CPC (Colder Products Company) is the leader in the design and manufacture of single-use connection technology and connectors for the biopharmaceutical market. CPC offers a wide variety of solutions including sterile connect, sterile disconnect, SIP connections and open connects. Our innovative designs provide flexibility for biopharmaceutical manufacturers to easily combine multiple components, single-use or hybrid systems including process containers, tubing manifolds, transfer lines, bioreactors, and other bioprocessing equipment.

Easy to use and robust single-use connectors from CPC maintain flow path sterility and integrity while enabling biopharmaceutical manufacturers to improve production yields, decrease time to market and reduce costs. Our genderless sterile connectors simplify process integration, maximize flexibility, and streamline supply chains. CPC makes peoples' lives better by developing innovative high-quality products that make media transfer safe and easy.

QUALITY

At CPC, everyone is involved in meeting or exceeding our customers' expectations from our suppliers to our distribution network, and most important, our employees. CPC measures and continually improves our standards of product quality, support services and overall customer and employee satisfaction. CPC's Quality System conforms to ISO 9001 and ISO 13485 standards. Products for biopharmaceutical applications are manufactured in our two ISO Class 7 certified cleanrooms.

Learn more about our cleanrooms and quality control processes at:
cpcworldwide.com/resources-support/quality-compliance



EXPERIENCE

CPC is the leading provider of quick connect couplings, fittings, disconnects and combination connectors used in fluid transfer. We innovate, engineer and manufacture fit-for-purpose products in close collaboration with our customers.

Founded in Minnesota in 1978, CPC has built a successful, growing company by focusing exclusively on critical points of connection within fluid management systems. CPC's reach is global with operations in the US, Germany and China, sales offices in ten countries and hundreds of distributor partners and OEM solution providers around the world.

CPC's biopharma team includes an innovative research and development group solely focused on creating the next generation of single-use technologies, with dedicated product managers, technical specialists, quality engineers and test lab expertise.

Our single-use and closed systems connectors empower our customers' solutions to be safer, more efficient and reliable. CPC biopharma experts provide media handling expertise for our customers as well as to the industry. These resources include:

- Channel Management Team – supporting our OEM and integrator partners.
- Applications Development Team – serving as consultants to our end user customers.
- Customer Fulfillment and Inside Sales Teams – serving our channels and end customers.

CPC offers application and operator training designed to provide guidance on where and how single-use technology can be used or optimized in the manufacturing process. For more details visit cpcworldwide.com/training.

SUPPLY CHAIN

With a commercial model designed to be market neutral, CPC is committed to offering consistent pricing programs, common delivery lead times and product availability information to all customers. Our market neutrality ensures that CPC retains supply chain integrity, ensures accountability and upholds our reputation as a world-class organization.

Additionally, as part of CPC's commitment to meeting the needs of biopharma customers, our products are produced in multiple cleanroom manufacturing facilities. This redundancy is designed to maintain product availability, manufacturing efficiency and reliability of manufacturing processes.

ONLINE RESOURCES

Visit cpcworldwide.com/bio for answers to your questions about our company and products.

VALIDATION TEST REPORTS

Validation test reports provide details of all the testing that has been performed on the product to ensure confidence at every point of connection. Extractables data can also be requested.

PRODUCT VIDEOS

Check out some of the latest innovations, technologies, and product tutorials in our CPC biopharma videos. Our video library contains instructions on how to assemble CPC connectors as well as best practices and tips to ensure you get the most out of every connection.

APPLICATION ARTICLES

CPC's industry experts share their knowledge on specific biopharmaceutical applications and how single-use technologies have helped our customers improve production.

CAD MODELS

See our connectors from all angles, anytime, anywhere. Get immediate access to 2D drawings and 3D models for use in your manufacturing process diagrams or to fit your specific needs. Simply register on our site to download CAD models in many different file formats.

REGULATORY & COMPLIANCE DOCUMENTS

CPC follows strict regulatory compliance standards to ensure the quality of our supply of our products. The materials used in our broad portfolio of products are compliant with various regulatory bodies including NSF, RoHs, REACH and more. Download the documents you require to meet regulatory and compliance standards.

ASK OUR ENGINEERS

We're here to help. When you have questions, CPC's team of expert engineers has answers. From flow rates to material compatibility and more, we specialize in providing media fluid connection solutions to meet the requirements of your most complex biopharma applications. Looking for something more specific to your needs, reach out to one of our industry experts with a specific question.

VISIT CPCWORLDWIDE.COM/BIO

REGULATORY AND COMPLIANCE

ISO 13485 CERTIFICATION

ISO 13485 is recognized by regulators around the world as a good basis for addressing medical device design and manufacturing regulatory requirements. It allows us to enhance product safety by proactively identifying and managing product and project risks. Our quality management system is ISO 13485 certified, which allows us to better control the consistency of manufactured products.

ISO 9001 CERTIFICATION

ISO 9001 is a standard which assures consistency of a product ordered by customers. Organizations having ISO 9001 certification have demonstrated compliance to the ISO 9001:2015 requirements by an independent registration authority. CPC's Quality Management System has been approved and certified under the ISO 9001 standard.

CLEANROOM MANUFACTURING

CPC manufactures certain Life Sciences and Chemical Management product lines in cleanrooms certified by an external testing service to meet or exceed ISO Class 7 at 0.5 mm per ISO 14644. Certification data is available upon request.

ANIMAL DERIVED COMPONENT FREE (ADCF)

According to declarations from CPC's raw material suppliers, the materials used to manufacture the flow path components of the biopharmaceutical product lines do not contain substances of animal origin.

FDA

The U.S. Food and Drug Administration publishes, through the Code of Federal Regulations, standardized criteria which govern the acceptability of materials used in food contact.

REACH

REACH is the regulation for Registration, Evaluation, Authorisation and Restriction of Chemicals. It entered into force on 1st June 2007 to streamline and improve the former legislative framework on chemicals of the European Union (EU). REACH places greater responsibility on industry to manage the risks that chemicals may pose to the health and the environment. CPC publishes a list of CPC products that are compliant with the EU regulation 1907/2006.

RESTRICTION OF HAZARDOUS SUBSTANCES (ROHS)

This directive bans new electrical and electronic equipment containing more than agreed levels of lead, cadmium, mercury, hexavalent chromium, polybrominated biphenyl (PBB) and polybrominated diphenyl ether (PBDE) flame retardants.



UNDERSTANDING SINGLE-USE SYSTEMS

Increasing global demand for new biologics, vaccines and cell therapies is driving manufacturers to replace traditional stainless equipment with single-use systems, which consist of plastic-based processing equipment used in the development and production of biopharmaceutical drugs.

BENEFITS OF SINGLE-USE

Operational Efficiencies	Increases flexibility and faster batch turnaround.
Cost Effectiveness	Minimizes cleaning and validation requirements.
Economic Advantages	Reduces capital expenditures and facility footprints.
Safety and Quality	Improves sterility assurance while decreasing the risk of cross-contamination and product loss.
Flexibility	Facilitates multi-drug production and fast product changeover.
Sustainability	Consumes less water, energy and chemicals when compared to stainless-based processing. Single-use plastic waste is an excellent fuel source for waste-to-energy conversion.

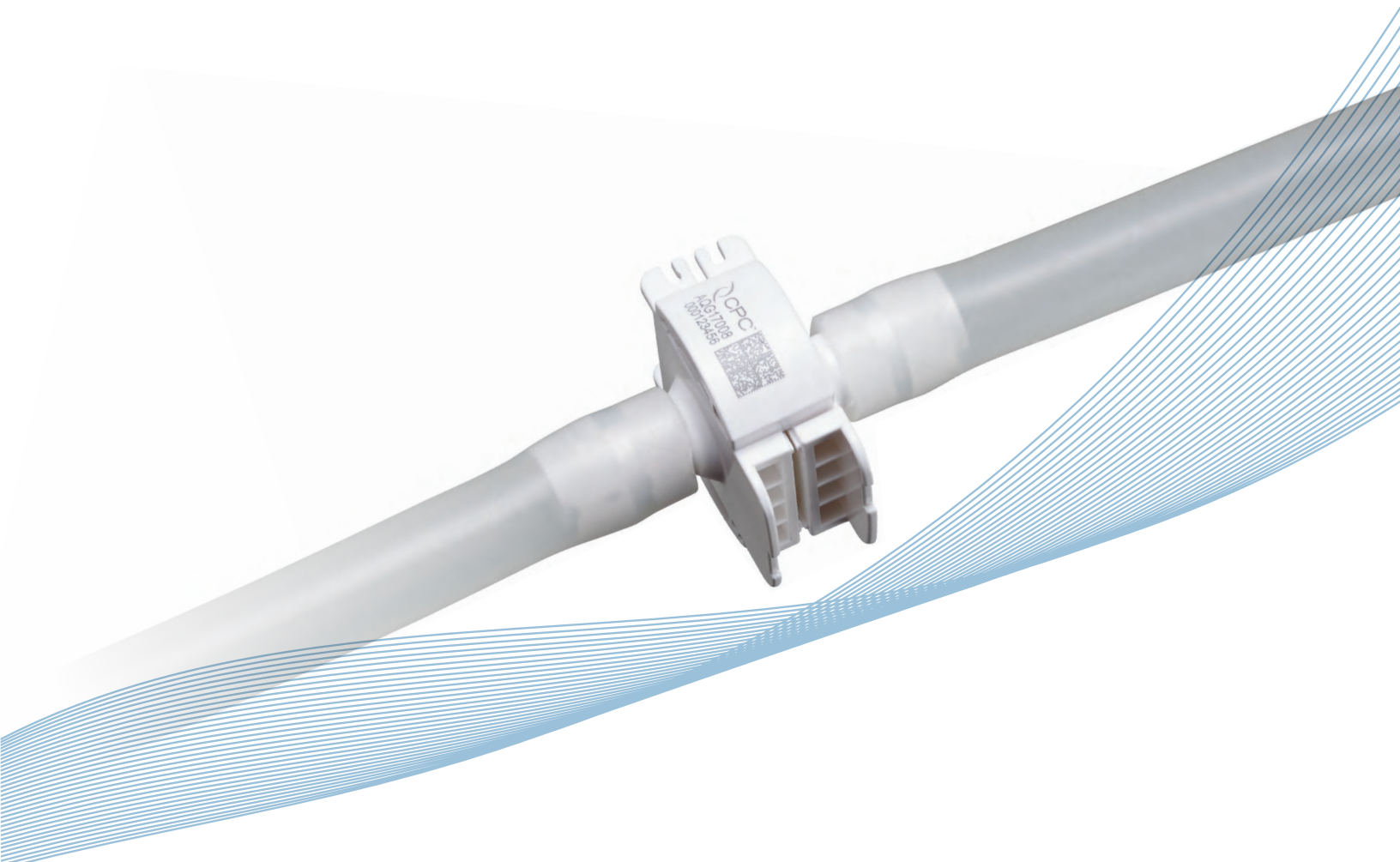

UNDERSTANDING THE BIOPHARMACEUTICAL MANUFACTURING PROCESS

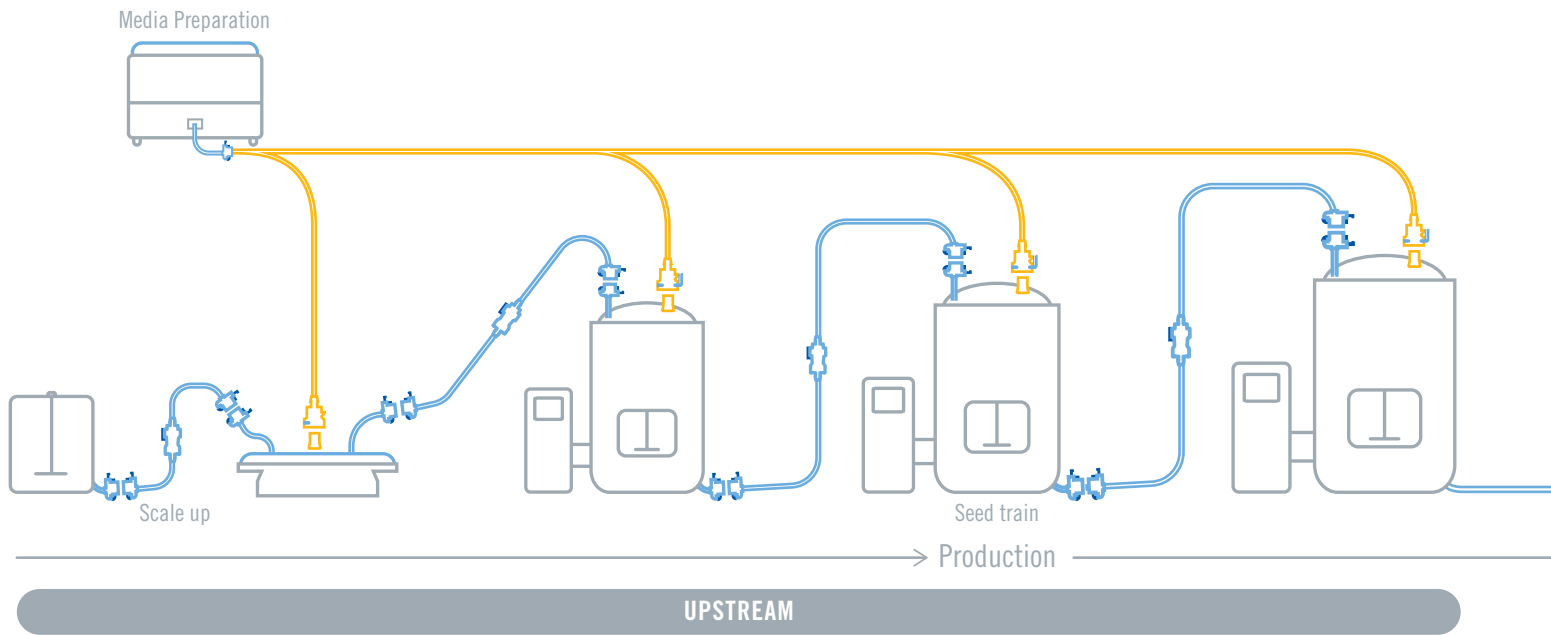

UPSTREAM

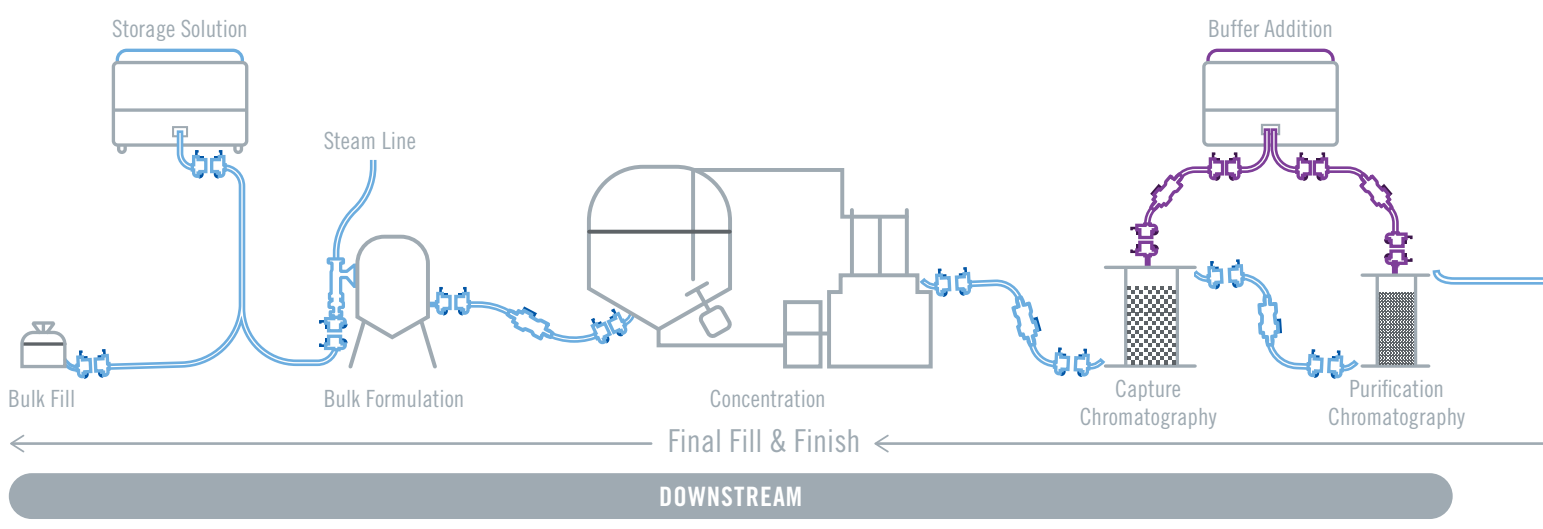

DOWNSTREAM

Main process flow line
Connectors: AseptiQuik® Series,
HFC Disconnect Series, Steam-Thru Series

Media Addition
Connectors: Open format, such as MPC Series,
MPX Series, MPU Series

Harsh Chemical Applications
Connectors: AQQ PPSU Series

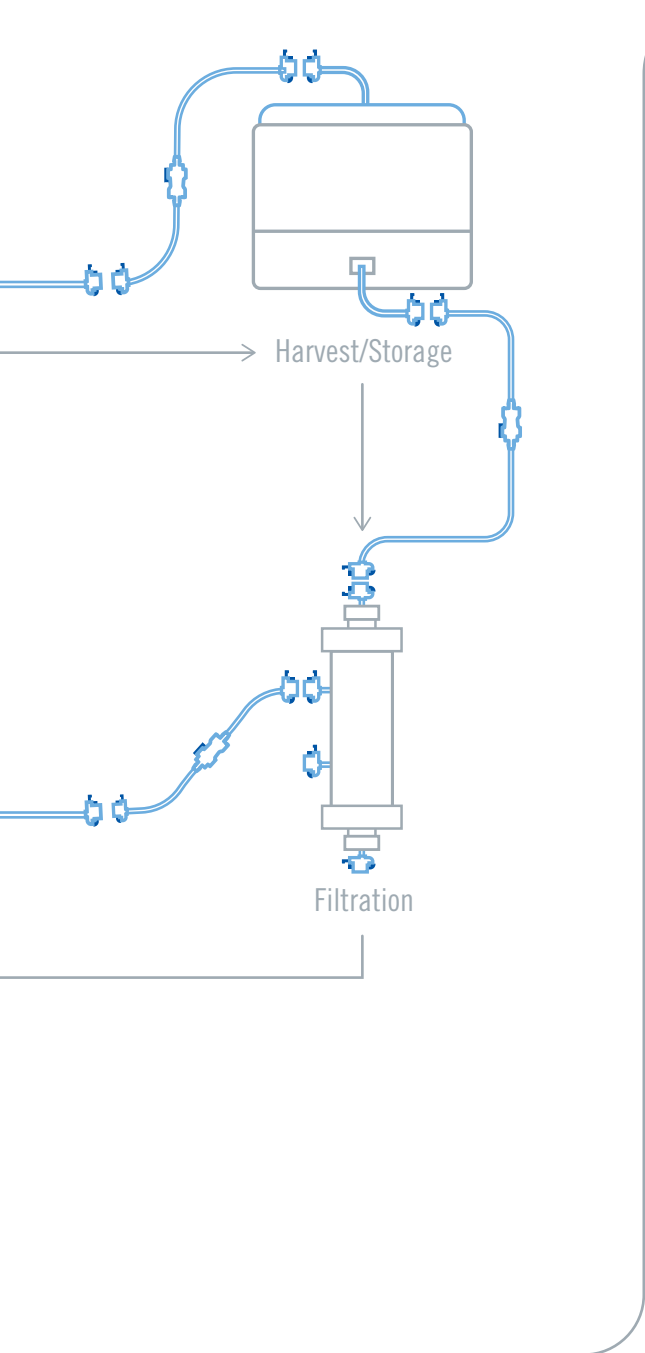

Single-use bioprocessing is designed to be flexible, efficient, and effective in the manufacture of drug substances, monoclonal antibodies, vaccines, biosimilars and regenerative medicines. The process is split into two main sections, upstream and downstream.

Along with growing the cell line, the purpose of the upstream process is to scale-up the volume of the target protein or cell from volumes as small as a vial to bioreactors that can be as large as 5,000L.

Once the target specimen has reached a target yield, it turns the corner towards the downstream process. The goal of the downstream line is to clarify, purify and filter the target. Reaching this goal is done with processes such as clarification, viral inactivation, chromatography and various types of filtration. The final step is fill and finish, where the target cell has been grown and purified to the point where it can be used for filling syringes or other devices to give to a patient to start their healing process.

ASEPTIC CONNECTION TECHNOLOGY* PAGES 10-23

12 MICROCNX® SERIES CONNECTORS: Sterile connection for your 1/8" flow applications

MATERIAL: Polycarbonate, silicone

TERMINATIONS: 1/16"; 3/32" & 1/8" ID hose barb (1.6mm, 2.4mm and 3.2mm)



16 ASEPTIQUICK® S SERIES CONNECTORS: Sterile connection for your 1/4" flow applications

MATERIAL: Polycarbonate, silicone

TERMINATIONS: 1/8"; 1/4"; 3/8" ID hose barb (3.2mm, 6.4mm and 9.5mm); 1/4"; 3/4" sanitary & MPC insert



18 ASEPTIQUICK® G SERIES CONNECTORS: Sterile connection for your 1/2" flow applications

MATERIAL: Polyphenylsulfone, polycarbonate and silicone

TERMINATIONS: 1/4"; 3/8"; 1/2"; 3/4" ID hose barb (6.4mm, 9.5mm, 12.7mm, 19.0mm) & 3/4"; 1 1/2" sanitary & MPC insert



20 ASEPTIQUICK® L SERIES CONNECTORS: Sterile connection for your 1" flow applications

MATERIAL: Polyphenylsulfone, polycarbonate and silicone

TERMINATIONS: 3/4"; 1" ID hose barb (19.0 mm; 25.4 mm); 1-1/2" sanitary



22 ASEPTIQUICK® W SERIES CONNECTORS: Sterile connection for your 1 1/2" flow applications

MATERIAL: Polycarbonate, silicone

TERMINATIONS: 1"; 1 1/4"; 1 1/2" ID hose barb (25.4mm; 31.75mm; 38.1mm); 1-1/2" sanitary



STERILE DISCONNECTION TECHNOLOGY* PAGES 24-29

28 HFC DISCONNECT SERIES

MATERIAL: Polysulfone, alloy spring, and silicone

TERMINATIONS: 1/4"; 3/8" & 1/2" ID hose barb (6.4mm, 9.5mm & 12.7mm)



ASEPTIC COMBINATION CONNECTORS PAGES 30-35

34 ASEPTIQUICK® G DC SERIES CONNECTORS: Sterile connection and disconnection combination for 1/2" flow applications

MATERIAL: Polycarbonate

TERMINATIONS: 1/4"; 3/8"; 1/2" ID hose barb (6.4mm; 9.5mm and 12.7mm)



OPEN FORMAT CONNECTION TECHNOLOGY PAGES 36-49

40 MPC SERIES CONNECTORS: Open-format connection for your 3/8" flow applications

MATERIAL: Polycarbonate, polysulfone and silicone

TERMINATIONS: 1/8"; 1/4" & 3/8" ID hose barb (3.2mm, 6.4mm, 9.5mm)



42 MPX SERIES CONNECTORS: Open-format connection for your 1/2" flow applications

MATERIAL: Polycarbonate, polysulfone, and silicone

TERMINATIONS: 3/8"; 1/2" ID hose barb (9.5mm & 12.7mm)



44 MPC/MPX BACK-TO-BACK SERIES ADAPTERS: Connect single-use systems that may feature identical connections at the end of their tubing.

MATERIAL: Polycarbonate, polysulfone and silicone



46 MPC/MPX SANITARY SERIES CONNECTORS: Attaches directly to 3/4", 1" & 1-1/2" sanitary terminations to provide greater flexibility for integrating components into single-use or hybrid process systems.

MATERIAL: Polysulfone and silicone

TERMINATIONS: 3/4", 1"; 1-1/2" sanitary



48 MPU SERIES CONNECTORS: Open-format twist-to-lock connection for 3/4" flow applications

MATERIAL: Polysulfone and silicone

TERMINATIONS: 3/4" (19.0mm) & 1" ID (25.4 mm)



STEAM-IN-PLACE CONNECTION TECHNOLOGY PAGES 50-57

54 STEAM-THRU® SERIES CONNECTORS: Hybrid connection between stainless steel and single use applications

MATERIAL: Polysulfone and silicone

TERMINATIONS: 3/8" & 1/2" ID hose barb (9.5mm & 12.7mm) 3/4"; 1 1/2" sanitary



56 ASEPTIQUIK® STC SERIES CONNECTORS: Hybrid connection between stainless steel and single use applications, with a single-use AseptiQuik included.

MATERIAL: Polycarbonate, polysulfone and silicone

TERMINATIONS: 3/4"; 1 1/2" sanitary



*If you don't see a product line, please contact your CPC representative for more information.



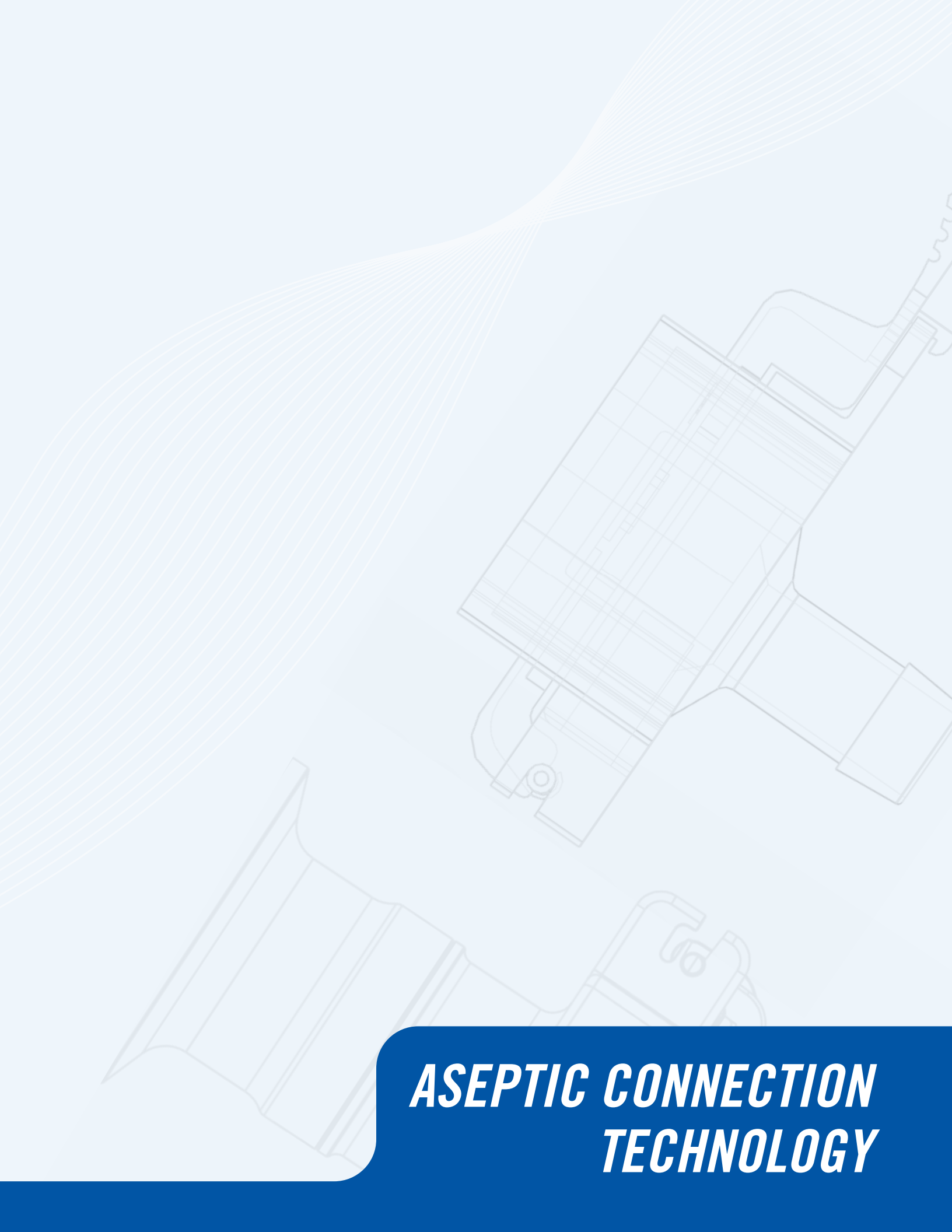

***ASEPTIC CONNECTION
TECHNOLOGY***

MICROCNX® SERIES CONNECTORS

MicroCNX® Connectors introduce a new category of aseptic micro-connectors that provide a simple, efficient method of connecting tubing for small-format biomanufacturing assemblies. MicroCNX connectors are the modern alternative to the cumbersome, industrial process of tube welding. Building on the inventiveness of CPC, the leader in single-use connection technology, the MicroCNX line of connectors is engineered specifically for the challenging conditions of biologic media transfer in bioprocessing, cell therapy and gene therapy applications.



SPECIFICATIONS

OPERATING PRESSURE

Up to 60 psi, 4.1 bar
Up to 75 psi, 5.1 bar for 48 hours

OPERATING TEMPERATURE

34°F to 104°F (1°C to 40°C)

TERMINATIONS

1/16", 3/32" 1/8" ID hose barb (1.6mm, 2.4mm, 3.2mm)

MATERIALS

Main Components: Polycarbonate (white)

Seals: Silicone (clear), platinum-cured

Protective Cover: Polypropylene (teal)

Membrane: Hydrophobic Polyethersulfone

STERILIZATION

Gamma: Up to 50kGy irradiation.

Autoclave: One cycle up to 266°F (130°C) for 60 minutes

FEATURES

PINCH-CLICK-PULL →

Easy to use →

Genderless →

CPC Click →

BENEFITS

Intuitive three-step connection process reduces risk of operator error

Lowers risk of operator error and related performance, reliability and safety concerns

Eases single-use systems specifications with one part number for both halves

Audible confirmation of assembly with no additional hardware required

TYPICAL FLOW RATE

Cv Value Range: 0.04-0.27
for MicroCNX hose barb terminations



Cv values represent the approximate expected flow rate in gallons per minute of water at room temperature for a 1 PSI pressure drop. The flow is generally constrained by the smallest diameter, which in some cases will be the termination diameter and not the Nominal Flow Path.

Caution: CPC does not recommend the use of PVC tubing with the polycarbonate MicroCNX® Series Connectors. Leachables from PVC tubing could be incompatible with polycarbonate material and affect product performance. Determining product application suitability is solely the customer's responsibility. CPC does not guaranty or warrant product suitability for any application or use.

NOTE

Validation and Extractables data can be requested at cpcworldwide.com/MicroCNX

DID YOU KNOW

MicroCNX connectors eliminate the need to purchase, calibrate, validate, maintain, and allocate clean room space for tube welding equipment.

Scan code to visit webpage



SCAN

cpcworldwide.com/MicroCNX

MICROCNX® SERIES DIMENSIONS

POLYCARBONATE with teal cover For autoclave or gamma irradiation applications.



TERMINATION	METRIC EQ.	PART NO.	A	B	C
1/16" HOSE BARB	1.6 mm	CNX17001HT	0.93" (23.6 mm)	2.05" (52.1 mm)	1.49" (37.8 mm)
3/32" HOSE BARB	2.4 mm	CNX17003HT	0.93" (23.6 mm)	2.16" (54.9 mm)	1.49" (37.8 mm)
1/8" HOSE BARB	3.2 mm	CNX17002HT	0.93" (23.6 mm)	2.25" (57.2 mm)	1.49" (37.8 mm)

PRODUCT DIMENSIONS

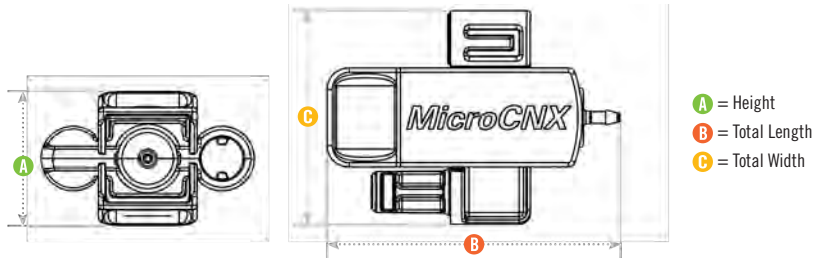

MICROCNX® CONNECTORS ASSEMBLY PROCEDURE

PINCH



Remove the protective cover on each half.

CLICK



Join halves and click together.

PULL



Pull membrane strips directly away from the connector.

Caution: CPC does not recommend the use of PVC tubing with the polycarbonate MicroCNX® Series Connectors. Leachables from PVC tubing could be incompatible with polycarbonate material and affect product performance. Determining product application suitability is solely the customer's responsibility. CPC does not guaranty or warrant product suitability for any application or use.

WHAT IS ASEPTIQUIK® STERILE TECHNOLOGY?

AseptiQuik® Connectors provide quick and easy sterile connections, even in non-sterile environments—a critical capability for biopharmaceutical manufacturers. Featuring a straightforward, simple three-step connection process and a wide range of termination options—including 1/8- to 1 1/2-inch sizes and genderless connections—the AseptiQuik series allows you to transfer media easily with less risk of error. Their robust, reliable performance eliminates the need for clamps, fixtures or tube welders, giving you sterile, high-quality single-use connections every time.

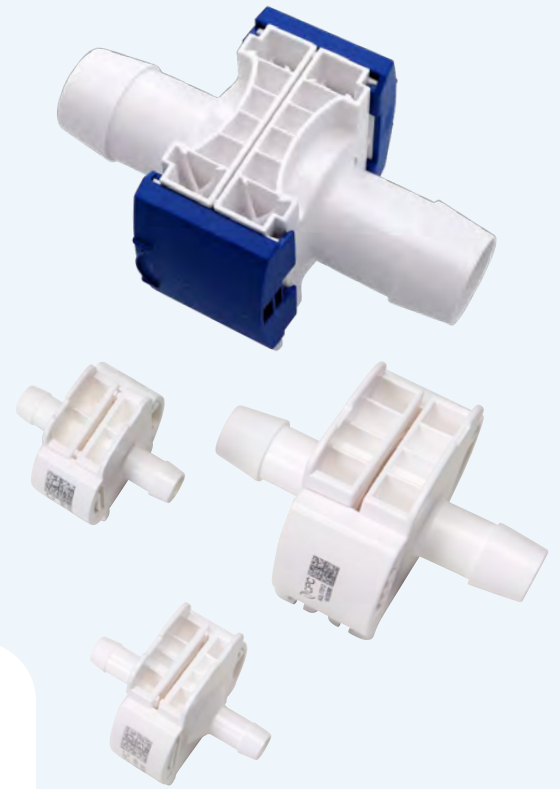

FEATURES

Genderless design →

Robust construction →

FLIP-CLICK-PULL →

Integrated pull tab covers →

CPC Click →

BENEFITS

Eases integration of single-use systems with universal mating between connectors of the same series

Repeatable and reliable performance with no additional hardware required

Innovative three-step connection process reduces risk of operator error (AQS, AQG, & AQL)

Pull tabs act as protective cover reducing part complexity and ensure simultaneous removal of both membranes

Audible confirmation of assembly

NOMINAL FLOW PATH (NFP) SIZE



	NFP	CV RANGE
AQS	(0.25")	0.19 – 1.74



	NFP	CV RANGE
AQG	(0.5")	1.5 – 31

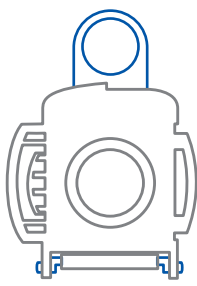

	NFP	CV RANGE
AQL	(1")	30 – 57

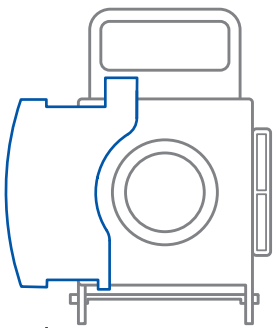

	NFP	CV RANGE
AQW	(1 1/2")	39 – 118

Cv values represent the approximate expected flow rate in gallons per minute of water at room temperature for a 1 PSI pressure drop. The flow is generally constrained by the smallest diameter, which in some cases will be the termination diameter and not the NFP.

ASEPTIQUIK CONNECTORS OPTIONS

	TERMINATIONS									MATERIALS			STERILIZATION (CHOOSE 1)		FLOW INFORMATION			
	HOSE BARB							SANITARY FLANGES			MPC INSERT	SILICONE SEAL	POLYCARBONATE	POLYPHENYLSULFONE	GAMMA COMPATIBLE	AUTOCLAVABLE	NOMINAL FLOW PATH	CY VALUE RANGE
	1/8"	1/4"	3/8"	1/2"	3/4"	1"	1 1/4"	1 1/2"	1/4"	3/4"								
ASEPTIQUIK® S SERIES	✓	✓	✓						✓	✓	✓		✓	✓	1/4"	0.19 – 1.74		
ASEPTIQUIK® G SERIES		✓	✓	✓	✓					✓	✓	✓	✓	✓	1/2"	1.5 - 31		
ASEPTIQUIK® L SERIES					✓	✓				✓	✓	✓	✓	✓	1"	30-57		
ASEPTIQUIK® W SERIES						✓	✓	✓		✓	✓		✓	✓	1 1/2"	39-118		

ASEPTIQUIK CONNECTORS ASSEMBLY PROCEDURE

FLIP

Unsnap and **flip** down the protective pull tab covers on each AseptiQuik connector half.



CLICK

Align the AseptiQuik connector halves with the pull tabs hanging down. Then, slide the two halves together, while independently squeezing each side until you hear an audible “CPC **Click**”.



PULL

To complete the connection, simply snap the pull tabs together by pushing on the CPC logos and **pull** the membranes from the AseptiQuik connector halves.



Scan code to watch AseptiQuik assembly video



<https://youtu.be/un2PnvUAZ0w>

Note – For AQW assembly see product page

ASEPTIQUIK® S SERIES CONNECTORS

AseptiQuik® S Connectors provide quick and easy sterile connections for small-flow applications, even in non-sterile environments. The "FLIP-CLICK-PULL" design of AseptiQuik S enables users to easily transfer small volumes of media with less risk of operator error than with traditional methods. The connector's genderless and robust design provides reliable performance without the need for clamps, fixtures or tube welders. Biopharmaceutical manufacturers can now make 1/8", 1/4" and 3/8" hose barb and 1/4" and 3/4" sanitary sterile connections with the quality and market availability they expect from the leader in single-use connection technology.

SPECIFICATIONS

OPERATING PRESSURE

Up to 60 psi, 4.1 bar

OPERATING TEMPERATURE

39°F to 104°F (4°C to 40°C)

STERILIZATION

- ☐ **Gamma:** Up to 50kGy irradiation
- ☐ **AutoClave High Temp (HT) Version:** Up to 266°F (130°C) for 60 minutes

TERMINATIONS

1/8", 1/4" and 3/8" ID hose barb (3.2mm, 6.4mm and 9.5mm), 1/4" and 3/4" sanitary and MPC insert

MATERIALS

Main Components:

Polycarbonate (white)

Pull Tabs/Caps:

Polycarbonate (blue, standard version)

Polycarbonate (white, HT version)

Seals:

Silicone (clear), platinum-cured

Membrane:

Polyethylene (standard version)

Hydrophobic polyethersulfone (HT version),

PTFE strip sticker

WARNING: Pressure, temperature, chemicals, and operating environment can affect the performance of couplings. It is the customer's responsibility to test the suitability of CPC's products in their own application conditions.

FEATURES

- Genderless →
- FLIP-CLICK-PULL →
- CPC Click →
- AQS-MPC Combination →
- AQS ¼" Sani with Smooth Bore →

BENEFITS

- Eases single-use systems specifications with one-part number for both halves
- Intuitive three-step connection process reduces risk of operator error
- Audible confirmation of connection with no additional hardware required
- Enables the ability to change a BPC or other single-use system with open format connections to closed systems
- Minimizes transitional flow disruptions throughout upstream processing

TYPICAL FLOW RATE:

Cv Value Range: 0.19 - 1.74 for AseptiQuik S

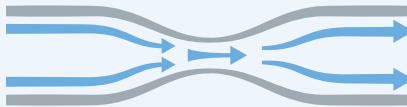

Cv values represent the approximate expected flow rate in gallons per minute of water at room temperature for a 1 PSI pressure drop. The flow is generally constrained by the smallest diameter, which in some cases will be the termination diameter and not the Nominal Flow Path.

NOTE

Validation and Extractables data can be requested at cpcworldwide.com/AseptiQuik-S

DID YOU KNOW

Did you know that the AseptiQuik S is perfect for simplifying the process to pull flask samples from your bioreactor?

Scan code to visit webpage



cpcworldwide.com/AseptiQuik-S

ASEPTIQUIK S SERIES DIMENSIONS

POLYCARBONATE with blue pull tabs - *For gamma irradiation applications.*



TERMINATION	METRIC EQ.	PART NO.	A	B	C
1/8" HOSE BARB	3.2 mm	AQS17002	2.25" (57.2 mm)	1.30" (33.0 mm)	0.50" (12.7 mm)
1/4" HOSE BARB	6.4 mm	AQS17004	2.25" (57.2 mm)	1.45" (36.8 mm)	0.65" (16.5 mm)
1/4" SANITARY	6.4 mm	AQS33004	2.25" (57.2 mm)	1.50" (38.1 mm)	0.70" (17.8 mm)
3/8" HOSE BARB	9.5 mm	AQS17006	2.25" (57.2 mm)	1.45" (36.8 mm)	0.65" (16.5 mm)
3/4" SANITARY	19.1 mm	AQS33012	2.25" (57.2 mm)	1.60" (40.6 mm)	0.80" (20.3 mm)
MPC INSERT		AQS17MPC	2.25" (57.2 mm)	1.49" (37.9 mm)	0.69" (17.5 mm)

POLYCARBONATE HT with white pull tabs - *For autoclave or gamma irradiation applications.*



TERMINATION	METRIC EQ.	PART NO.	A	B	C
1/8" HOSE BARB	3.2 mm	AQS17002HT	2.25" (57.2 mm)	1.30" (33.0 mm)	0.50" (12.7 mm)
1/4" HOSE BARB	6.4 mm	AQS17004HT	2.25" (57.2 mm)	1.45" (36.8 mm)	0.65" (16.5 mm)
1/4" SANITARY	6.4 mm	AQS33004HT	2.25" (57.2 mm)	1.50" (38.1 mm)	0.70" (17.8 mm)
3/8" HOSE BARB	9.5 mm	AQS17006HT	2.25" (57.2 mm)	1.45" (36.8 mm)	0.65" (16.5 mm)
3/4" SANITARY	19.1 mm	AQS33012HT	2.25" (57.2 mm)	1.60" (40.6 mm)	0.80" (20.3 mm)
MPC INSERT		AQS17MPCHT	2.25" (57.2 mm)	1.49" (37.9 mm)	0.69" (17.5 mm)

PRODUCT DIMENSIONS

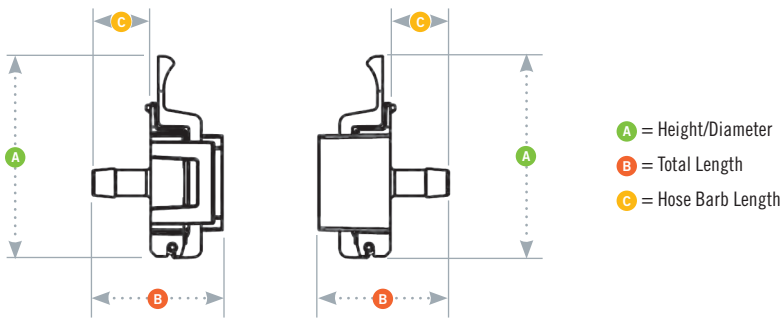

NOTES

ASEPTIQUIK® G SERIES CONNECTORS

AseptiQuik® G Connectors enable quick and easy sterile connections, even in non-sterile environments. The easy-to-use genderless design simplifies system integration and minimizes the risk of operator error. The connectors' robust construction provides enhanced user confidence and reliable performance without the need for clamps, fixtures or tube welders. Biopharmaceutical manufacturers benefit from a full range of interchangeable 1/4" to 1-1/2" termination solutions with the quality and market availability they expect from the leader in single-use connection technology.



SPECIFICATIONS

OPERATING PRESSURE

Up to 60 psi, 4.1 bar
Up to 75 psi, 5.1 bar for 48 hours (excluding AQGMPC)

OPERATING TEMPERATURE

34°F to 104°F (1°C to 40°C)

STERILIZATION

Standard (blue) and PPSU (purple) Version:

Gamma: up to 50kGy

High Temperature (white) Version:

Gamma: up to 50kGy

Autoclave:

One cycle up to 266°F (130°C) for 60 minutes

TERMINATIONS

1/4", 3/8", 1/2", 3/4" ID hose barb (6.4mm, 9.5mm, 12.7mm, 19.0mm) and 3/4", 1-1/2" sanitary

MATERIALS

Main Components:

Polycarbonate (white), (standard and HT versions)
Polyphenylsulfone (off white) (PPSU version)

Pull Tabs/Caps:

Polycarbonate (blue, standard), (white, HT version), (purple, PPSU version)

Seals:

Silicone (clear), platinum-cured

Membranes:

Polyethylene (standard and PPSU versions),
Hydrophobic polyethersulfone (HT version),
PTFE strip sticker

WARNING: Pressure, temperature, chemicals, and operating environment can affect the performance of couplings. It is the customer's responsibility to test the suitability of CPC's products in their own application conditions.

FEATURES

Genderless →

FLIP-CLICK-PULL →

CPC Click →

Chemical Compatibility and pH Range →

BPA-free →

BENEFITS

- Eases single-use systems specifications with one-part number for both halves
- Intuitive three-step connection process reduces risk of operator error
- Audible confirmation of connection with no additional hardware required
- AseptiQuik PPSU enables genderless connection for a greater range of chemical applications, offering versatile connections across downstream processes with a pH range from 2 to 12
- AseptiQuik PPSU meets a broader range of Application Requirements

TYPICAL FLOW RATE:

Cv Value Range: 1.5 - 31
for AseptiQuik G

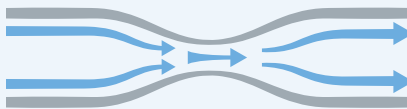

Cv values represent the approximate expected flow rate in gallons per minute of water at room temperature for a 1 PSI pressure drop. The flow is generally constrained by the smallest diameter, which in some cases will be the termination diameter and not the Nominal Flow Path.

Scan code to visit webpage



cpcworldwide.com/AseptiQuik-G

NOTE

Validation and Extractables data can be requested at cpcworldwide.com/AseptiQuik-G

DID YOU KNOW

Did you know that the AseptiQuik G is perfect for connecting different buffers to your chromatography skid?

ASEPTIQUIK G SERIES DIMENSIONS

POLYCARBONATE with blue pull tabs - *For gamma irradiation applications.*



TERMINATION	METRIC EQ.	PART NO.	A	B	C
1/4" HOSE BARB	6.4 mm	AQG17004	2.62" (66.6 mm)	1.62" (41.2 mm)	0.82" (20.8 mm)
3/8" HOSE BARB	9.5 mm	AQG17006	2.62" (66.6 mm)	1.62" (41.2 mm)	0.82" (20.8 mm)
1/2" HOSE BARB	12.7 mm	AQG17008	2.62" (66.6 mm)	1.95" (49.5 mm)	1.15" (29.2 mm)
3/4" HOSE BARB	19.1 mm	AQG17012	2.62" (66.6 mm)	2.36" (59.9 mm)	1.56" (39.6 mm)
3/4" SANITARY	19.1 mm	AQG33012	2.62" (66.6 mm)	1.66" (42.2 mm)	0.86" (21.8 mm)
1-1/2" SANITARY	38.1 mm	AQG33024	2.62" (66.6 mm)	1.93" (48.9 mm)	1.13" (28.6 mm)
MPC INSERT		AQG17MPC	2.62" (66.6 mm)	1.50" (38.1 mm)	0.70" (17.8 mm)

POLYCARBONATE HT with white pull tabs - *For autoclave or gamma irradiation applications.*



TERMINATION	METRIC EQ.	PART NO.	A	B	C
1/4" HOSE BARB	6.5 mm	AQG17004HT	2.62" (66.6 mm)	1.62" (41.2 mm)	0.82" (20.8 mm)
3/8" HOSE BARB	9.5 mm	AQG17006HT	2.62" (66.6 mm)	1.62" (41.2 mm)	0.82" (20.8 mm)
1/2" HOSE BARB	12.7 mm	AQG17008HT	2.62" (66.6 mm)	1.95" (49.5 mm)	1.15" (29.2 mm)
3/4" HOSE BARB	19.1 mm	AQG17012HT	2.62" (66.6 mm)	2.36" (59.9 mm)	1.56" (39.6 mm)
3/4" SANITARY	19.1 mm	AQG33012HT	2.62" (66.6 mm)	1.66" (42.2 mm)	0.86" (21.8 mm)
1-1/2" SANITARY	38.1 mm	AQG33024HT	2.62" (66.6 mm)	1.93" (48.9 mm)	1.13" (28.6 mm)
MPC INSERT		AQG17MPCHT	2.62" (66.6 mm)	1.50" (38.1 mm)	0.70" (17.8 mm)

POLYPHENYLSULFONE with purple pull tabs - *For gamma irradiation applications.*



TERMINATION	METRIC EQ.	PART NO.	A	B	C
1/4" HOSE BARB	6.4 mm	AQG17104	2.62" (66.6 mm)	1.62" (41.2 mm)	0.82" (20.8 mm)
3/8" HOSE BARB	9.5 mm	AQG17106	2.62" (66.6 mm)	1.62" (41.2 mm)	0.82" (20.8 mm)
1/2" HOSE BARB	12.7 mm	AQG17108	2.62" (66.6 mm)	1.95" (49.5 mm)	1.15" (29.2 mm)
3/4" HOSE BARB	19.1 mm	AQG17112	2.62" (66.6 mm)	2.36" (59.9 mm)	1.56" (39.6 mm)
3/4" SANITARY	19.1 mm	AQG33112	2.62" (66.6 mm)	1.66" (42.2 mm)	0.86" (21.8 mm)
1-1/2" SANITARY	38.1 mm	AQG33124	2.62" (66.6 mm)	1.93" (48.9 mm)	1.13" (28.6 mm)

PRODUCT DIMENSIONS

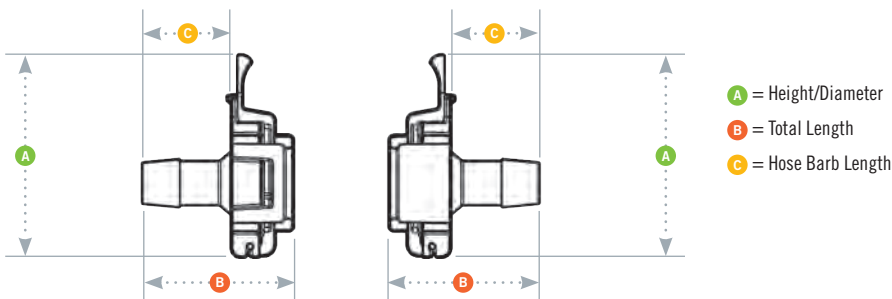

ASEPTIQUIK® L SERIES CONNECTORS

AseptiQuik® L Connectors enable quick and easy sterile connections, in large-volume, high-flow production environments. The large-format, 3/4", 1" hose barb and 1-1/2" sanitary genderless design simplifies system integration and minimizes the risk of operator error. The connectors' robust construction provides reliable performance without the need for clamps, fixtures or tube welders. Biopharmaceutical manufacturers benefit from the interchangeable connection sanitary flow solutions for full-scale bioprocessing production environments with the quality and market availability they expect from the leader in single-use connection technology.



SPECIFICATIONS

OPERATING PRESSURE

Up to 60 psi, 4.1 bar
Up to 75 psi, 5.1 bar for 48 hours

OPERATING TEMPERATURE

34°F to 104°F (1°C to 40°C)

STERILIZATION

Standard (blue) and PPSU (purple) Version:

Gamma: up to 50kGy

High Temperature (white) Version:

Gamma: up to 50kGy

Autoclave:

One cycle up to 266°F (130°C) for 60 minutes

TERMINATIONS

3/4", 1" ID hose barb (19.0 mm, 25.4 mm)
and 1-1/2" sanitary

MATERIALS

Main Components:

Polycarbonate (white), (standard and HT versions)

Polyphenylsulfone (off white) (PPSU version)

Pull Tabs/Caps:

Polycarbonate (blue, standard), (white, HT version), (purple, PPSU version)

Seals:

Silicone (clear), platinum-cured

Membranes:

Polyethylene (standard and PPSU versions),

Hydrophobic polyethersulfone (HT version),

PTFE strip sticker

WARNING: Pressure, temperature, chemicals, and operating environment can affect the performance of couplings. It is the customer's responsibility to test the suitability of CPC's products in their own application conditions.

FEATURES

Genderless →

FLIP-CLICK-PULL →

CPC Click →

Large Internal Diameter →

Chemical Compatibility and pH Range →

BENEFITS

Eases single-use systems specifications with one-part number for both halves

Intuitive three-step connection process reduces risk of operator error

Audible confirmation of connection with no additional hardware required

Fast and efficient fluid transfer of large volumes under low pressures

AseptiQuik PPSU enables genderless connection for a greater range of chemical applications, offering versatile connections across downstream processes with a pH range from 2 to 12

TYPICAL FLOW RATE:

Cv Value Range: 30 - 57
for AseptiQuik L

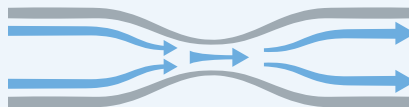

Cv values represent the approximate expected flow rate in gallons per minute of water at room temperature for a 1 PSI pressure drop. The flow is generally constrained by the smallest diameter, which in some cases will be the termination diameter and not the Nominal Flow Path.

Scan code to visit webpage



cpcworldwide.com/AseptiQuik-L

NOTE

Validation and Extractables data can be requested at cpcworldwide.com/AseptiQuik-L

DID YOU KNOW

Did you know that the AseptiQuik L is perfect for connecting TFF, TFD, and ATF and other filtration processes that require large flow volumes?

ASEPTIQUIK L SERIES DIMENSIONS

POLYCARBONATE with blue pull tabs - *For gamma irradiation applications.*



TERMINATION	METRIC EQ.	PART NO.	A	B	C
3/4" HOSE BARB	19.1 mm	AQL17012	4.22" (107.2 mm)	2.95" (74.9 mm)	1.50" (38.1 mm)
1" HOSE BARB	25.4 mm	AQL17016	4.22" (107.2 mm)	3.15" (80.0 mm)	1.70" (43.2 mm)
1-1/2" SANITARY	38.1 mm	AQL33024	4.22" (107.2 mm)	2.57" (65.3 mm)	1.13" (28.7 mm)

POLYCARBONATE HT with white pull tabs - *For autoclave or gamma irradiation applications.*



TERMINATION	METRIC EQ.	PART NO.	A	B	C
3/4" HOSE BARB	19.1 mm	AQL17012HT	4.22" (107.2 mm)	2.95" (74.9 mm)	1.50" (38.1 mm)
1" HOSE BARB	25.4 mm	AQL17016HT	4.22" (107.2 mm)	3.15" (80.0 mm)	1.70" (43.2 mm)
1-1/2" SANITARY	38.1 mm	AQL33024HT	4.22" (107.2 mm)	2.57" (65.3 mm)	1.13" (28.7 mm)

POLYPHENYLSULFONE with purple pull tabs - *For gamma irradiation applications.*



TERMINATION	METRIC EQ.	PART NO.	A	B	C
3/4" HOSE BARB	19.1 mm	AQL17112	4.22" (107.2 mm)	2.95" (74.9 mm)	1.50" (38.1 mm)
1" HOSE BARB	25.4 mm	AQL17116	4.22" (107.2 mm)	3.15" (80.0 mm)	1.70" (43.2 mm)
1-1/2" SANITARY	38.1 mm	AQL33124	4.22" (107.2 mm)	2.57" (65.3 mm)	1.13" (28.7 mm)

PRODUCT DIMENSIONS

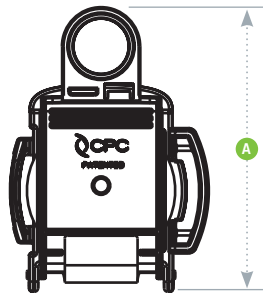
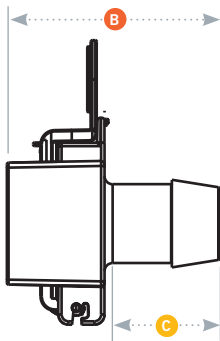

- A = Height/Diameter
- B = Total Length
- C = Hose Barb Length

ASEPTIQUIK® W SERIES CONNECTORS

Genderless AseptiQuik® W Series Connectors with nominal 1 ½" flow path enable quick and easy sterile connections, in large-volume, high-flow production and process intensification environments. The genderless design simplifies system integration and minimizes the risk of operator error. The connectors' robust construction provides reliable performance without the need for clamps or fixtures. Biopharmaceutical manufacturers benefit from interchangeable 1", 1 ¼", and 1 ½" termination sizes for full-scale bioprocessing production environments with the quality and market availability they expect from the leader in the single-use connection technology.



SPECIFICATIONS

OPERATING PRESSURE

Up to 60 psi, 4.1 bar
Up to 75 psi, 5.1 bar for 48 hours

OPERATING TEMPERATURE

34°F to 104°F (1°C to 40°C)

STERILIZATION

- Gamma:** up to 50 kGy irradiation
- Autoclave High Temp (HT) Version:** Up to 266°F (130°C) for 60 minutes

TERMINATIONS

1", 1 ¼", 1 ½" Hose barb, 1 ½" Sanitary (25.4mm, 31.75mm, 38.1mm, 38.1mm)

MATERIALS

Main components:

Polycarbonate (white)

Shipping Clip:

Polycarbonate (clear)

Side latch:

Polyphenylsulfone (blue)

Pull Tabs/Caps:

Polycarbonate (white, HT version)

Pull Tab Guide:

Polyphenylsulfone (gray)

Seals:

Silicone (clear), platinum-cured

Membrane:

Hydrophobic Polyethersulfone (HT version), PTFE strip sticker

WARNING: Pressure, temperature, chemicals, and operating environment can affect the performance of couplings. It is the customer's responsibility to test the suitability of CPC's products in their own application conditions.

FEATURES

- Genderless
- FLIP - CLICK - PULL- SNAP
- Secure Side Latches
- Membrane Pull Tabs
- No Secondary Component Needed
- Largest AseptiQuik Flow Diameter (1 ½" Nominal Flow Path)

BENEFITS

- Eases single-use systems specifications with one-part number for both halves
- Intuitive four-step connection process reduces risk of operator error
- Increases connector robustness for wide variety of applications
- Enables simultaneous and secure removal of both membranes
- No need to purchase and store extra materials or tools to complete your sterile connection process
- Move liquid medias faster to increase process efficiency

TYPICAL FLOW RATE:

Cv Value Range: 39-118 for AseptiQuik W

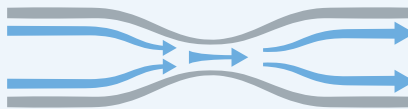

Cv values represent the approximate expected flow rate in gallons per minute of water at room temperature for a 1 PSI pressure drop. The flow is generally constrained by the smallest diameter, which in some cases will be the termination diameter and not the Nominal Flow Path.

NOTE

Validation and Extractables data can be requested at cpcworldwide.com/AseptiQuik-W



cpcworldwide.com/AseptiQuik-W

ASEPTIQUIK® W SERIES DIMENSIONS

POLYCARBONATE HT WITH WHITE PULL TABS - For autoclave or gamma irradiation applications.



TERMINATION	METRIC EQ.	PART NO.	A	B	C
1" HOSE BARB	25.4 mm	AQW17016HT	5.77" (146.6 mm)	4.00" (101.6 mm)	1.51" (38.4 mm)
1 1/4" HOSE BARB	31.8 mm	AQW17020HT	5.77" (146.6 mm)	4.39" (111.5 mm)	1.91" (48.5 mm)
1 1/2" HOSE BARB	38.1 mm	AQW17024HT	5.77" (146.6 mm)	4.91" (124.7 mm)	2.42" (61.5 mm)
1 1/2" SANITARY	38.1 mm	AQW33024HT	5.77" (146.6 mm)	3.66" (93.0 mm)	1.17" (29.7 mm)

PRODUCT DIMENSIONS

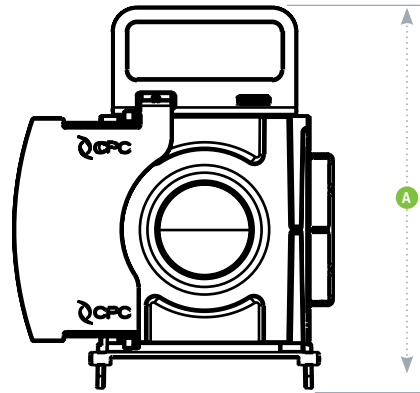
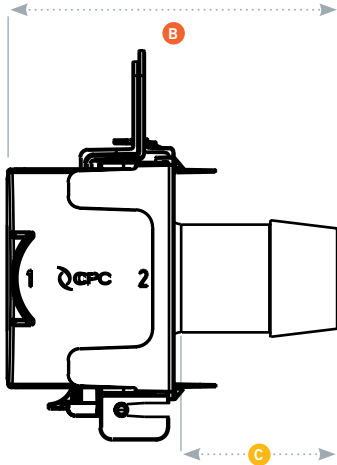

- A = Height/Diameter
- B = Total Length
- C = Hose Barb Length

ASEPTIQUIK® W ASSEMBLY PROCEDURE

STEP 1

Flip the pull tab down while disengaging it from the shipping clip until fully open and clicked into place



STEP 2

Align the two halves and press together until you hear a "click" sound of the 1st stage connection latches



STEP 3

Pull the membranes by placing one hand in the handle of the pull tabs and the other hand on the termination (Option 1) OR the pull tab guides (Option 2). (Ensure Step 3 is completed prior to moving to Step 4)



STEP 4

Remove the clear shipping clips then Snap side "1" first, followed by side "2" on each side latch and confirm they are attached to the body

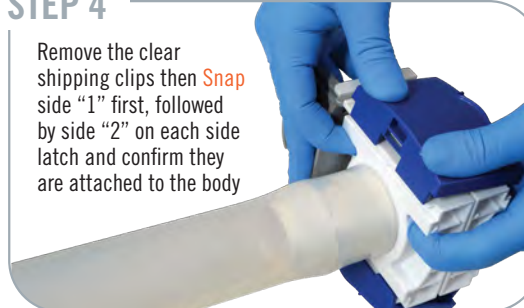

Scan code to watch AseptiQuik W assembly video



cpcworldwide.com/AQWassembly





***STERILE DISCONNECTION
TECHNOLOGY***

WHAT IS STERILE DISCONNECTION TECHNOLOGY?

CPC's sterile disconnection technology enables simple, quick sterile disconnection of your single-use systems with just the press of a thumb latch. Internal valves within the sterile disconnect technology close and seal upon disconnect, protecting the closed system fluid pathway on each side of the disconnected system. The HFC Disconnect product line enables sterile disconnections from tubing ¼" to ½" ID and connected sets feature a protective thumb latch to prevent accidental disconnections.



FEATURES

- Intuitive one-step disconnection process → No requirement for additional equipment to make sterile disconnection
Minimize operator error and ease standard operating procedure creation and training
- Automatic shutoff valves → Stop flow upon disconnect
- Protective thumb latch cover → Eliminate accidental disconnects
- Laser marked item number and lot number → Full traceability to raw material source
- Alloy C-276 internal flow path spring → Enable broader application compatibility

BENEFITS

NOMINAL FLOW PATH (NFP) SIZE

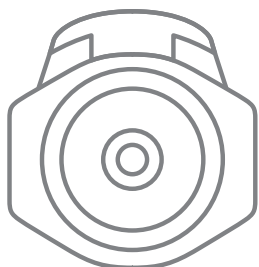

	NFP	CV RANGE
HFC	(0.375")	0.3 - 2.5

Cv values represent the approximate expected flow rate in gallons per minute of water at room temperature for a 1 PSI pressure drop. The flow is generally constrained by the smallest diameter, which in some cases will be the termination diameter and not the NFP.

OUR KNOWLEDGE IS YOURS.
Get useful information on SUT validation.

THE PATH TO CONFIDENCE AT EVERY POINT OF CONNECTION

ACCESS E-BOOK HERE

<https://www.cpcworldwide.com/Biopharma-Campaigns/SUT-Validation-E-Book>

HFC DISCONNECT OPTIONS

	TERMINATIONS			MATERIALS		PRODUCT FEATURE	STERILIZATION (CHOOSE 1)		FLOW INFORMATION	
	HOSE BARB			SILICONE SEAL	POLYSULFONE		GAMMA COMPATIBLE	AUTOCLAVABLE	NOMINAL FLOW PATH	CV VALUE RANGE
	1/4"	3/8"	1/2"							
CONNECTED SET	✓	✓	✓	✓	✓	✓	✓	✓	3/8"	0.3–2.5
UNCONNECTED HALVES	✓	✓	✓	✓	✓		✓	✓	3/8"	0.3–2.5

HFC DISCONNECT PROCEDURE

STEP 1



STEP 2



HFC DISCONNECT SERIES CONNECTORS

HFC Disconnects enable sterile disconnection of single-use biopharma and cell and gene therapy manufacturing systems. With an easy push of the connector thumb latch, sterility is maintained on both sides of the system during the disconnection process. The HFC Disconnect sets include protective thumb latch covers to help reduce the chance of accidental disconnection, and are laser marked with item and lot number for complete batch traceability.



SPECIFICATIONS

OPERATING PRESSURE

Up to 75 psi, 5.17 bar

OPERATING TEMPERATURE

34° F to 104° F (1° C to 40°C)

STERILIZATION

- Gamma:** Up to 50 kGy irradiation
- Autoclave:** Up to 270°F (132°C), 60 minutes, one cycle

TERMINATIONS

1/4", 3/8" and 1/2" ID hose barb (6.4mm, 9.5mm and 12.7mm)

MATERIALS

Main components:

Polysulfone (amber tint)

O-rings: Silicone (clear), platinum-cured

Flow Path Springs: Alloy C-276

WARNING: Pressure, temperature, chemicals, and operating environment can affect the performance of couplings. It is the customer's responsibility to test the suitability of CPC's products in their own application conditions.

Scan code to visit webpage



cpcworldwide.com/HFC-Disconnect

FEATURES

- Intuitive one-step disconnection process →
- Automatic shutoff valves →
- Protective thumb latch cover →
- Laser etched item number and lot number →
- Alloy C-276 internal flow path spring →

BENEFITS

- No requirement for additional equipment to make sterile disconnection
- Stop flow and eliminate need for pinch clamps
- Guard against accidental disconnects
- Full traceability to raw material source
- Enabling broader application compatibility

TYPICAL FLOW RATE:

Cv Value Range: 0.3 - 2.5 for HFC Disconnect

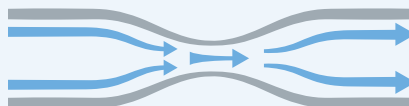

Cv values represent the approximate expected flow rate in gallons per minute of water at room temperature for a 1 PSI pressure drop. The flow is generally constrained by the smallest diameter, which in some cases will be the termination diameter and not the Nominal Flow Path.

NOTE

Validation and Extractables data can be requested at cpcworldwide.com/HFC-Disconnect

DID YOU KNOW

The HFC Disconnect is great for post-use filter integrity testing (e.g. bubble point testing).

HFC DISCONNECT SERIES DIMENSIONS

COUPLING SETS - Polysulfone



TERMINATION	METRIC EQ.	PART NO.	A	B
1/4" HOSE BARB	6.4 mm ID	HFCD39SET4HC	1.54" (39.1 mm)	3.71" (94.3 mm)
3/8" HOSE BARB	9.5 mm ID	HFCD39SET6HC	1.54" (39.1 mm)	3.71" (94.3 mm)
1/2" HOSE BARB	12.5 mm ID	HFCD39SET8HC	1.54" (39.1 mm)	4.29" (109 mm)

COUPLING BODIES - Polysulfone



TERMINATION	METRIC EQ.	PART NO.	A	B
1/4" HOSE BARB	6.4 mm ID	HFCD17439MHC	1.44" (36.6 mm)	2.78" (70.6 mm)
3/8" HOSE BARB	9.5 mm ID	HFCD17639MHC	1.44" (36.6 mm)	2.78" (70.6 mm)
1/2" HOSE BARB	12.5 mm ID	HFCD17839MHC	1.44" (36.6 mm)	3.07" (78.0 mm)

COUPLING INSERTS - Polysulfone



TERMINATION	METRIC EQ.	PART NO.	A	B
1/4" HOSE BARB	6.4 mm ID	HFCD22439MHC	1.00" (25.4 mm)	2.00" (50.8 mm)
3/8" HOSE BARB	9.5 mm ID	HFCD22639MHC	1.00" (25.4 mm)	2.00" (50.8 mm)
1/2" HOSE BARB	12.5 mm ID	HFCD22839MHC	1.00" (25.4 mm)	2.29" (58.2 mm)

MATING PARTS



PART	PART NO.	A	B
SEALING CAP	HFC32039	1.44" (36.6 mm)	2.73" (69.3 mm)
SEALING PLUG	HFC30039M	1.00" (25.4 mm)	1.80" (45.7 mm)

All measurements are in inches (millimeters) unless otherwise noted. Tubing must meet stated inside and outside diameters. Couplings are pictured with valves unless otherwise noted.

PRODUCT DIMENSIONS

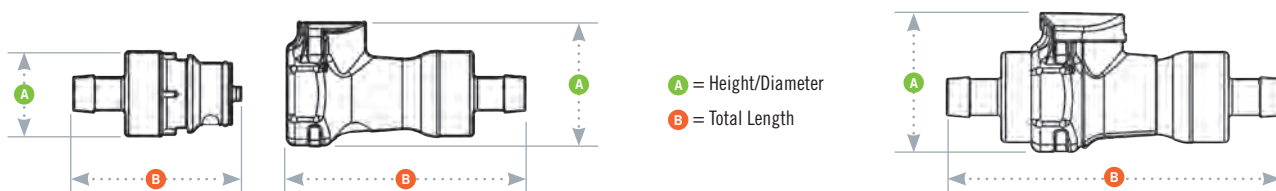



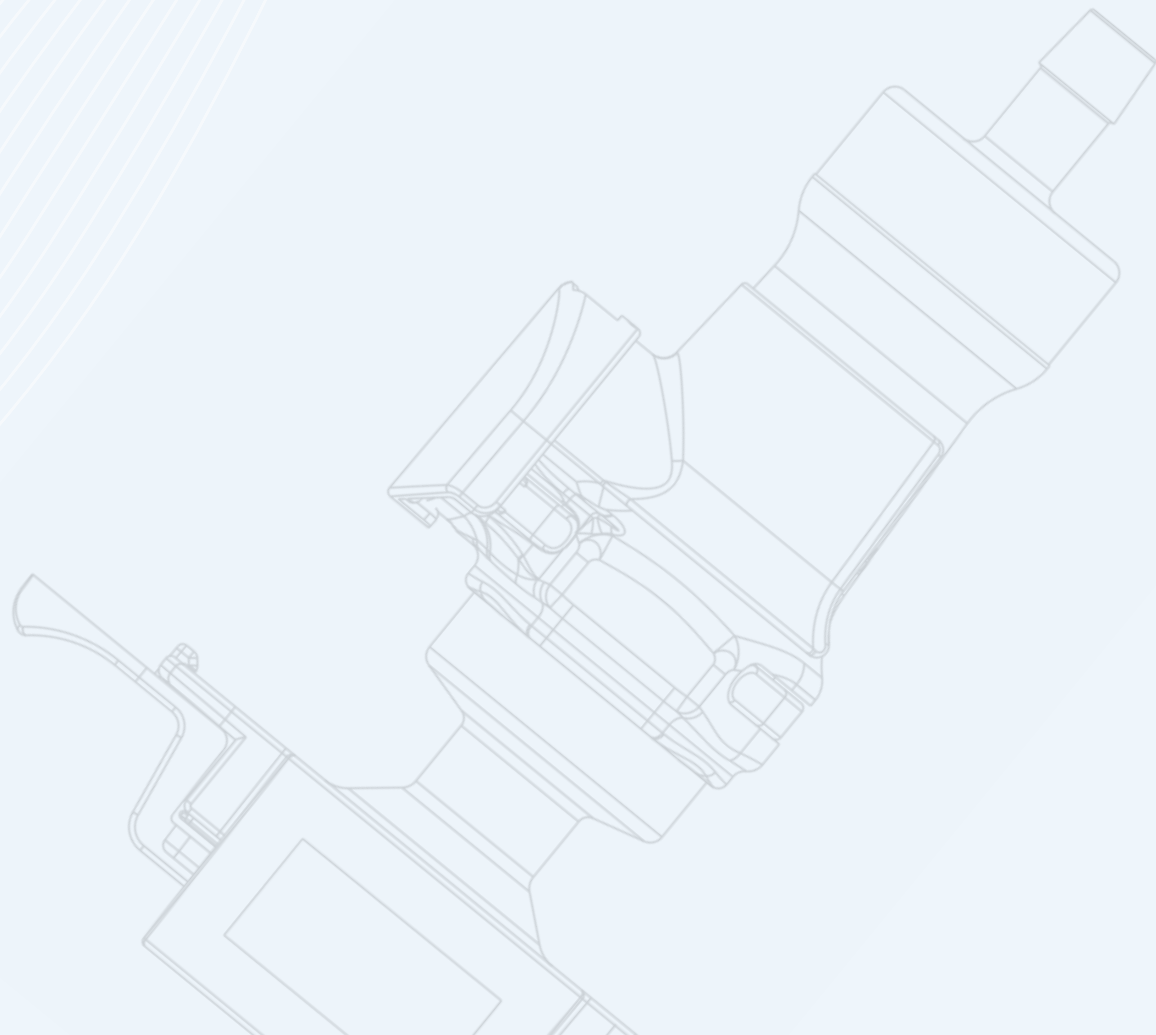

***ASEPTIC COMBINATION
CONNECTORS***

WHAT IS ASEPTIC COMBINATION TECHNOLOGY?

Aseptic Combination Technology offers both a sterile connection AND a sterile disconnection in the same connector. This connect/disconnect combination connector helps process engineers and manufacturers make quick, easy, and sterile connections and disconnections, even in non-sterile environments. CPC's sterile combination technology is engineered using CPC's single-use technology, enabling users to make easy media transfers with less risk of operator error. When media transfers are complete, combination connectors easily and securely disconnect to help maintain sterility. Automatic shutoff valves support this disconnect, providing reliable performance without the need for tube welders.



FEATURES

- Genderless → Connects with any part number within the AseptiQuik G product line
- FLIP - CLICK - PULL → Intuitive three-step connection process reduces risk of operator error
- Simple Two-Step Disconnection → Maintains system sterility in both sides of the system via disconnect process
- Membrane Pull Tabs → Ensure simultaneous and secure removal of both membranes
- Automatic Shutoff Valves → Eliminate the need for tube sealers post disconnect process
- Protective Thumb Latch Cover → Eliminates accidental disconnects
- Alloy C-276 internal flow path spring → Enables broader application compatibility

BENEFITS

NOMINAL FLOW PATH (NFP) SIZE

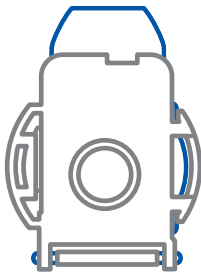

	NFP	CV RANGE
AQG DC	(0.5")	0.8 – 1.9

Cv values represent the approximate expected flow rate in gallons per minute of water at room temperature for a 1 PSI pressure drop. The flow is generally constrained by the smallest diameter, which in some cases will be the termination diameter and not the NFP.

ASEPTIQUIK COMBINATION CONNECTORS OPTIONS

	TERMINATIONS									MATERIALS		STERILIZATION (CHOOSE 1)		FLOW INFORMATION		
	HOSE BARB						SANITARY FLANGES			SILICONE SEAL	POLYCARBONATE	POLYPHENYLSULFONE	GAMMA COMPATIBLE	AUTOCLAVABLE	NOMINAL FLOW PATH	CV VALUE RANGE
	1/8"	1/4"	3/8"	1/2"	3/4"	1"	1/4"	3/4"	1 1/2"							
ASEPTIQUIK® G DC SERIES		✓	✓	✓						✓	✓		✓		1/2"	0.8 - 1.9

ASEPTIQUIK G DC ASSEMBLY PROCEDURE

STEP 1



Unsnap and flip down the protective pull tab covers on each connector half.

STEP 2

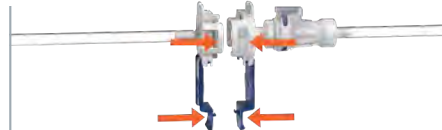

Align the connector halves with the pull tabs hanging down. Slide the two halves together. Independently squeeze each side of the connector until you hear an audible "CPC Click."

STEP 3



To complete the connection, simply snap the pull tabs together by pushing on the CPC logos and pull the membranes from the connector.

ASEPTIQUIK G DC DISASSEMBLY PROCEDURE

STEP 1



Remove protective thumb latch cover.

STEP 2



Press the thumb latch to disconnect.

ASEPTIQUIK® G DC SERIES CONNECTORS

AseptiQuik® G DC Series Connector is the first all-in-one, genderless, single-use connection technology to offer both a sterile connection and a sterile disconnection. With the AseptiQuik G DC connector, manufacturers can make quick and easy sterile connections and disconnections – even in non-sterile environments.

The intuitive Flip - Click - Pull design of the AseptiQuik G DC connector enables users to transfer media easily with less risk of operator error. After transfer is complete, a simple two-step disconnection maintains media sterility by preventing environmental ingress into the media flow path.

The connector's robust design and automatic shutoff valves provide reliable performance without the need for fixtures or tube welders/sealers.



SPECIFICATIONS

OPERATING PRESSURE

Up to 60 psi, 4.1 bar
Up to 75 psi, 5.1 bar for 48 hours

OPERATING TEMPERATURE

34°F to 104°F (1°C to 40°C)

STERILIZATION

Gamma: up to 50 kGy irradiation

TERMINATIONS

1/4", 3/8", 1/2" hose barb
(6.4mm, 9.5mm, 12.7mm)

MATERIALS

Main components:

Polycarbonate (white)

Thumb latch:

Polycarbonate (blue)

Pull Tabs/Caps:

Polycarbonate (blue)

Seals:

Silicone (clear), platinum-cured

Membrane:

Polyethylene

Springs:

Alloy C-276

WARNING: Pressure, temperature, chemicals, and operating environment can affect the performance of couplings. It is the customer's responsibility to test the suitability of CPC's products in their own application conditions.

FEATURES

- Genderless →
- FLIP - CLICK - PULL →
- Simple Two-Step Disconnection →
- Membrane Pull Tabs →
- Automatic Shutoff Valves →
- Protective Thumb Latch Cover →
- Alloy C-276 internal flow path spring →

BENEFITS

- Connects with any part number within the AseptiQuik G product line
- Intuitive three-step connection process reduces risk of operator error
- Maintains system sterility in both sides of the system via disconnect process
- Ensure simultaneous and secure removal of both membranes
- Eliminate the need for tube sealers post disconnect process
- Eliminates accidental disconnects
- Enables broader application compatibility

TYPICAL FLOW RATE:

Cv Value Range: 0.8-1.90
for AseptiQuik G DC hose barb terminations

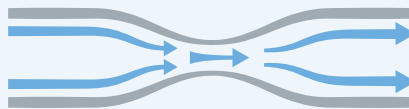

Cv values represent the approximate expected flow rate in gallons per minute of water at room temperature for a 1 PSI pressure drop. The flow is generally constrained by the smallest diameter, which in some cases will be the termination diameter and not the Nominal Flow Path.

NOTE

Validation and Extractables data can be requested at cpcworldwide.com/AseptiQuik-GDC

Scan code to visit webpage



cpcworldwide.com/AseptiQuik-GDC

ASEPTIQUIK® G DC SERIES DIMENSIONS

POLYCARBONATE - For gamma irradiation applications.



TERMINATION	TUBING	METRIC EQ.	PART NO.	A	B	C
1/4" HOSE BARB ASEPTIQUIK G DC BODY	1/4"	6.4 mm	AQGDC17004	2.62" (66.5 mm)	4.37" (111.0 mm)	0.60" (15.2 mm)
3/8" HOSE BARB ASEPTIQUIK G DC BODY	3/8"	9.5 mm	AQGDC17006	2.62" (66.5 mm)	4.37" (111.0 mm)	0.60" (15.2 mm)
1/2" HOSE BARB ASEPTIQUIK G DC BODY	1/2"	12.7 mm	AQGDC17008	2.62" (66.5 mm)	4.66" (118.4 mm)	0.89" (22.6 mm)

PRODUCT DIMENSIONS

- A = Height/Diameter
- B = Total Length
- C = Hose Barb Length

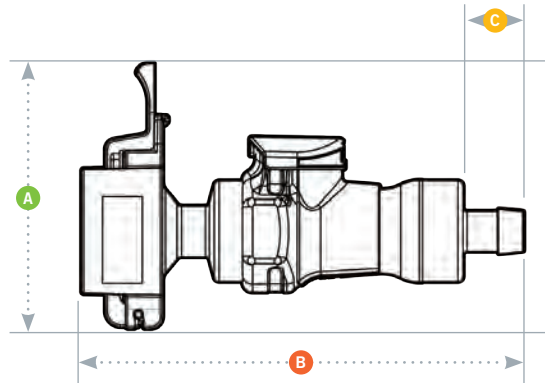

COMBINATION STERILE CONNECTIONS FOR SINGLE-USE APPLICATIONS



View White Paper Here →







***OPEN FORMAT CONNECTION
TECHNOLOGY***

WHAT IS OPEN FORMAT CONNECTION TECHNOLOGY?

CPC's open format connectors (also known as quick connectors or quick disconnectors) are a straightforward and simple way to incorporate media transfer technology between your single-use systems. Our open format products feature male and female connector halves with caps and plugs to seal off the fluid pathway of the single-use system. Simply removing the cap and plug from each half of the system and joining the male and female connection links the fluid pathways of your two separate systems.

CPC's open format products—the MPC Series, MPX Series, and MPU Series Connectors—enable connections from 1/8" ID tubing to 1" ID tubing. In addition, the MPC and MPX connectors feature an ergonomic thumb latch and optional locking sleeve to prevent accidental disconnection.

Sanitary adapters within the MPC and MPX product lines facilitate integration of components into single-use or hybrid (single-use to stainless) process systems.

Back-to-back adapters within the MPC and MPX product lines can be used to connect two identical body components or insert components. For additional flexibility, reducer options enable connection between an MPC and MPX product to link 1/8" to 1/2" ID tubing.



FEATURES

- Ergonomic thumb latch → Easy to operate – even with gloved hands
- Parting line-free hose barb → Creates seamless connection to tubing
- Optional locking sleeve (MPC, MPX) → Prevents accidental disconnection
- Mix and match termination sizes → Enables flexibility in your application

BENEFITS

NOMINAL FLOW PATH (NFP) SIZE



	NFP	CV RANGE
MPC	(0.375")	0.1 – 8.0
BACK-TO-BACK BODIES & INSERTS	(0.375" – 0.5")	2.0 – 6.0



	NFP	CV RANGE
MPX	(0.5")	4.0 – 17
BACK-TO-BACK BODIES & INSERTS	(0.375" – 0.5")	23 – 32



	NFP	CV RANGE
MPU	(1")	18 – 41

Cv values represent the approximate expected flow rate in gallons per minute of water at room temperature for a 1 PSI pressure drop. The flow is generally constrained by the smallest diameter, which in some cases will be the termination diameter and not the NFP.

OPEN FORMAT CONNECTION OPTIONS

	TERMINATIONS							PRODUCT FEATURES	FLOW-PATH MATERIALS			STERILIZATION (CHOOSE 1)		FLOW INFORMATION		
	HOSE BARB						SANITARY		OPTIONAL LOCKING SLEEVE	SILICONE SEAL	POLYCARBONATE	POLYSULFONE	GAMMA COMPATIBLE	AUTOCLAVEABLE	NOMINAL FLOW PATH	CV VALUE RANGE
	1/8"	1/4"	3/8"	1/2"	3/4"	1"	3/4"									
MPC	✓	✓	✓					✓	✓	✓	✓	✓	✓	1/4"	0.1 – 8.0	
MPC SANITARY							✓	✓	✓	✓	✓	✓	✓	1/4"	0.1 – 8.0	
MPC BACK-TO-BACK BODIES									✓	✓	✓	✓	✓	1/4" - 1/2"	2.0 – 6.0	
MPC BACK-TO-BACK INSERTS									✓	✓	✓	✓	✓	1/4" - 1/2"	2.0 – 6.0	
MPX			✓	✓				✓	✓	✓	✓	✓	✓	1/2"	4.0 – 17	
MPX SANITARY							✓	✓	✓	✓	✓	✓	✓	1/2"	4.0 – 17	
MPX BACK-TO-BACK BODIES									✓	✓	✓	✓	✓	1/4" - 1/2"	23 – 32	
MPX BACK-TO-BACK INSERTS									✓	✓	✓	✓	✓	1/4" - 1/2"	23 – 32	
MPU					✓	✓			✓	✓	✓	✓	✓	1"	18 – 41	

MPC/MPX ASSEMBLY PROCEDURE

STEP 1

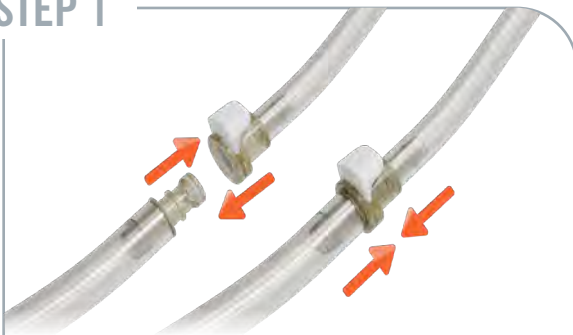

To connect two MPC or two MPX components, press the body (or cap) and insert (or plug) components together.

STEP 2

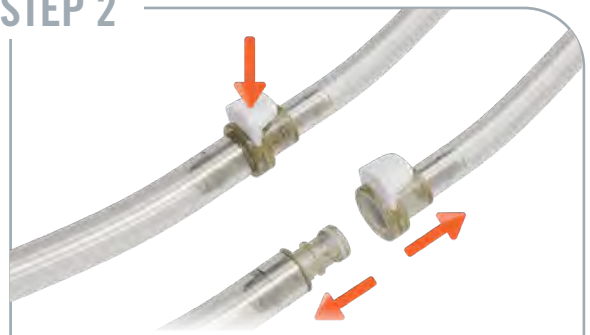

To disconnect two MPC or two MPX components, depress the thumb latch and separate the two components from one another.

NOTE: If using a body or cap component with a locking sleeve, twist to the “locked” position after connecting the two halves to prevent accidental disconnection. When you are ready to disconnect once again, twist the locking sleeve to the “unlocked” position.

MPC SERIES CONNECTORS

MPC Series Connectors add ease of use and security to critical fluid handling applications. Choose from a full line of connectors and configurations, including pressure sealing caps and plugs, in sizes to fit 1/8" to 3/8" tubing. MPC couplings offer optional locking sleeves to further guard against accidental disconnects. In addition, coupling halves can be rotated when connected to reduce tube kinks.



SPECIFICATIONS

OPERATING PRESSURE

Vacuum to 60 psi, 4.1 bar

OPERATING TEMPERATURE

Polycarbonate:

-40°F to 250°F (-40°C to 121°C)

Polysulfone:

-40°F to 300°F (-40°C to 149°C)

STERILIZATION

Gamma: Up to 50 kGy irradiation

Autoclave:

Polycarbonate: Up to 250°F (121°C),

30 minutes, up to 10 repetitions

Sterilize uncoupled only

Polysulfone: Up to 270°F (132°C),

60 minutes, up to 25 repetitions

Sterilize uncoupled only

TERMINATIONS

1/8" to 3/8" ID (3.2mm to 9.5mm)

MATERIALS

Main components:

Polycarbonate (purple tint)

Polysulfone (amber tint)

Locking sleeves:

Polysulfone (white)

Thumb Latches:

Polycarbonate (white)

PVDF (white)

O-rings:

Silicone (clear), platinum-cured

WARNING: Pressure, temperature, chemicals, and operating environment can affect the performance of couplings. It is the customer's responsibility to test the suitability of CPC's products in their own application conditions.

FEATURES

- Ergonomic thumb latch → Easy to operate – even with gloved hands
- Parting line-free hose barb → Prevent potential leak path
- Optional locking sleeve → Prevents accidental disconnection
- Various options on termination size and material → Better flexibility to fit more applications

BENEFITS

TYPICAL FLOW RATE:

Cv Value Range: 0.1 - 8
for MPC hose barb terminations

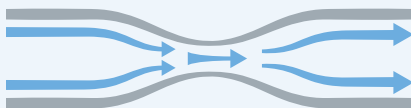

Cv values represent the approximate expected flow rate in gallons per minute of water at room temperature for a 1 PSI pressure drop. The flow is generally constrained by the smallest diameter, which in some cases will be the termination diameter and not the Nominal Flow Path.

NOTE

Validation and Extractables data can be requested at cpcworldwide.com/MPC

DID YOU KNOW

The MPC and MPX connectors are perfect for smaller bag systems for aliquoted media or other product stored in bags.

Scan code to visit webpage



cpcworldwide.com/MPC

MPC SERIES DIMENSIONS

COUPLING BODIES



TERMINATION	METRIC EQ.	POLYCARBONATE PART NO.	POLYSULFONE PART NO.	A	B
1/8" HOSE BARB	3.2 mm ID	MPC17002T03	MPC17002T39	0.96" (24.4 mm)	1.10" (27.9 mm)
1/4" HOSE BARB	6.4 mm ID	MPC17004T03	MPC17004T39	0.96" (24.4 mm)	1.30" (33.0 mm)
3/8" HOSE BARB	9.5 mm ID	MPC17006T03	MPC17006T39	0.96" (24.4 mm)	1.30" (33.0 mm)
1/8" HOSE BARB W/ LOCK	3.2 mm ID	MPCK17002T03	MPCK17002T39	1.02" (25.9 mm)	1.10" (27.9 mm)
1/4" HOSE BARB W/ LOCK	6.4 mm ID	MPCK17004T03	MPCK17004T39	1.02" (25.9 mm)	1.30" (33.0 mm)
3/8" HOSE BARB W/ LOCK	9.5 mm ID	MPCK17006T03	MPCK17006T39	1.02" (25.9 mm)	1.30" (33.0 mm)

COUPLING INSERTS



TERMINATION	METRIC EQ.	POLYCARBONATE PART NO.	POLYSULFONE PART NO.	A	B
1/8" HOSE BARB	3.2 mm ID	MPC22002T03M	MPC22002T39M	0.60" (15.2 mm)	1.09" (27.7 mm)
1/4" HOSE BARB	6.4 mm ID	MPC22004T03M	MPC22004T39M	0.60" (15.2 mm)	1.30" (33.0 mm)
3/8" HOSE BARB	9.5 mm ID	MPC22006T03M	MPC22006T39M	0.60" (15.2 mm)	1.30" (33.0 mm)

SEALING COMPONENTS



SEALING CAP	W/LOCK	MATERIAL	A	B
MPC32003	MPCK32003	Polycarbonate	0.96" (24.4 mm)	1.30" (33.0 mm)
MPC32039	MPCK32039	Polysulfone	0.99" (25.2 mm)	1.30" (33.0 mm)
SEALING PLUG		MATERIAL	A	B
MPC30003M		Polycarbonate	0.75" (19.1 mm)	1.24" (31.5 mm)
MPC30039M		Polysulfone	0.75" (19.1 mm)	1.24" (31.5 mm)

PRODUCT DIMENSIONS

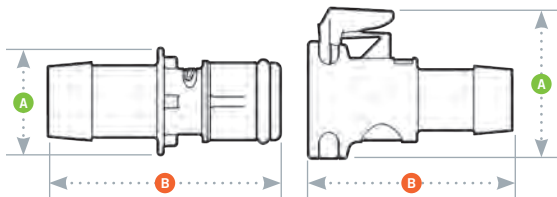

A = Height/Diameter

B = Total Length

MPX SERIES CONNECTORS

MPX Series Connectors add ease of use and security to your media transfer applications. Choose from a full line of connectors and configurations, including pressure sealing caps and plugs in sizes to fit 3/8" and 1/2" tubing. MPX couplings offer optional locking sleeves to further guard against accidental disconnects. In addition, coupling halves can be rotated when connected reducing tube kinks.



SPECIFICATIONS

OPERATING PRESSURE

Vacuum to 60 psi, 4.1 bar

OPERATING TEMPERATURE

Polycarbonate:

-40°F to 250°F (-40°C to 121°C)

Polysulfone:

-40°F to 300°F (-40°C to 149°C)

STERILIZATION

Gamma: Up to 50 kGy irradiation

Autoclave:

Polycarbonate: Up to 250°F (121°C),

30 minutes, up to 10 repetitions

Sterilize uncoupled only

Polysulfone: Up to 270°F (132°C),

60 minutes, up to 25 repetitions

Sterilize uncoupled only

TERMINATIONS

3/8" to 1/2" ID (9.5mm to 12.7mm)

MATERIALS

Main components:

Polycarbonate (purple tint)

Polysulfone (amber tint)

Locking sleeves:

PVDF (white)

Thumb Latches:

Polycarbonate (white)

PVDF (white)

O-rings:

Silicone (clear), platinum-cured

WARNING: Pressure, temperature, chemicals, and operating environment can affect the performance of couplings. It is the customer's responsibility to test the suitability of CPC's products in their own application conditions.

FEATURES

- Ergonomic thumb latch → Easy to operate – even with gloved hands
- Parting line-free hose barb → Prevents potential leak path
- Optional locking sleeve → Prevents accidental disconnection
- Mix and match termination sizes → Enables flexibility in your system and/or application

BENEFITS

TYPICAL FLOW RATE:

Cv Value Range: 4 - 17
for MPX

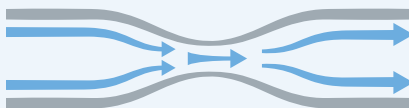

Cv values represent the approximate expected flow rate in gallons per minute of water at room temperature for a 1 PSI pressure drop. The flow is generally constrained by the smallest diameter, which in some cases will be the termination diameter and not the Nominal Flow Path.

NOTE

Validation and Extractables data can be requested at cpcworldwide.com/MPX

DID YOU KNOW

The MPC and MPX connectors are perfect for smaller bag systems for aliquoted media or other product stored in bags.

Scan code to visit webpage



SCAN

cpcworldwide.com/MPX

MPX SERIES DIMENSIONS

COUPLING BODIES



TERMINATION	METRIC EQ.	FLOW	POLYCARBONATE PART NO.	POLYSULFONE PART NO.	A	B
1/2" ID HOSE BARB	12.7 mm ID	.50"	MPX17803	MPX17839	1.28" (32.5 mm)	1.96" (49.8 mm)
1/2" ID HOSE BARB W/ LOCK	12.7 mm ID	.50"	MPXK17803	MPXK17839	1.28" (32.5 mm)	1.96" (49.8 mm)

COUPLING INSERTS



TERMINATION	METRIC EQ.	FLOW	POLYCARBONATE PART NO.	POLYSULFONE PART NO.	A	B
3/8" HOSE BARB	9.5 mm ID	.38"	MPX22603M	MPX22639M	0.85" (21.6 mm)	1.90" (48.3 mm)
1/2" HOSE BARB	12.7 mm ID	.50"	MPX22803M	MPX22839M	0.85" (21.6 mm)	1.90" (48.3 mm)

SEALING COMPONENTS



SEALING CAP	W/LOCK	MATERIAL	A	B
MPX32003	MPXK32003	Polycarbonate	1.28" (32.5 mm)	1.67" (42.4 mm)
MPX32039	MPXK32039	Polysulfone	1.28" (32.5 mm)	1.67" (42.4 mm)
SEALING PLUG		MATERIAL	A	B
MPX30003M		Polycarbonate	1.10" (27.9 mm)	1.66" (42.2 mm)
MPX30039M		Polysulfone	1.10" (27.9 mm)	1.66" (42.2 mm)

All measurements are in inches (millimeters) unless otherwise noted. Tubing must meet stated inside and outside diameters.

PRODUCT DIMENSIONS

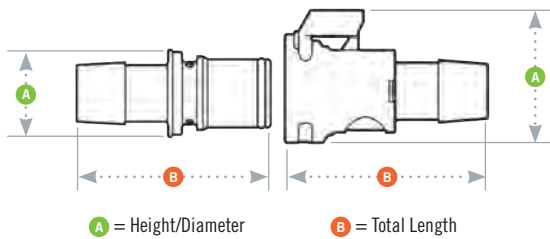

MPC/MPX BACK-TO-BACK SERIES ADAPTERS

MPC/MPX Back-to-Back Adapters give end users the flexibility of connecting single-use systems that feature identical coupling connections at the end of their tubing. Combining both MPC and MPX couplings provides a reducing option for users who need to transition between tubing diameters ranging from 1/8" to 1/2".



SPECIFICATIONS

OPERATING PRESSURE

Vacuum to 60 psi, 4.1 bar

OPERATING TEMPERATURE

Polycarbonate:

-40°F to 250°F (-40°C to 121°C)

Polysulfone:

-40°F to 300°F (-40°C to 149°C)

STERILIZATION

Gamma: Up to 50 kGy irradiation

Autoclave:

Polycarbonate: Up to 250°F (121°C),

30 minutes, up to 10 repetitions

Sterilize uncoupled only

Polysulfone: Up to 270°F (132°C),

60 minutes, up to 25 repetitions

Sterilize uncoupled only

MATERIALS

Main Components:

Polycarbonate (purple tint)

Polysulfone (amber tint)

Thumb Latches:

Polycarbonate (white)

PVDF (white)

O-rings:

Silicone (clear), platinum-cured

WARNING: Pressure, temperature, chemicals, and operating environment can affect the performance of couplings. It is the customer's responsibility to test the suitability of CPC's products in their own application conditions.

FEATURES

Compatible with MPC and MPX Series inserts

Tubing reduction option

Ergonomic thumb latches

BENEFITS

Easy conversion to industry standard connections or single-use systems

Allows easy transition between multiple size tubing from 1/8" to 1/2" ID

Easy to operate – even with gloved hands

TYPICAL FLOW RATE:

Cv Value Range: 2 - 32

for Back-to-Back hose barb terminations

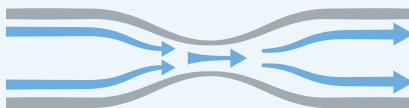

Cv values represent the approximate expected flow rate in gallons per minute of water at room temperature for a 1 PSI pressure drop. The flow is generally constrained by the smallest diameter, which in some cases will be the termination diameter and not the Nominal Flow Path.

Scan code to visit webpage



cpcworldwide.com/Back-to-Back-Adapters

NOTE

Validation and Extractables data can be requested at cpcworldwide.com/Back-to-Back-Adapters

DID YOU KNOW

The MPC and MPX connectors are perfect for smaller bag systems for aliquoted media or other product stored in bags.

MPC/MPX BACK-TO-BACK SERIES DIMENSIONS

MPC/MPX BACK-TO-BACK INSERT ADAPTERS - Polysulfone



PART NO.	TYPE	A	B
MPC22C2239M	MPC to MPC	0.74" (18.8)	2.04" (51.0)
MPC22X2239M	MPC to MPX	0.98" (25.0)	2.42" (61.5)
MPX22X2239M	MPX to MPX	0.98" (25.0)	2.73" (69.5)

MPC/MPX BACK-TO-BACK BODY ADAPTERS - Polycarbonate



PART NO.	TYPE	A	B
MPC17C1703	MPC to MPC	0.96" (24.5)	1.81" (46.0)
MPX17X1703	MPX to MPX	1.28" (32.5)	2.44" (62.0)
MPC17X1703	MPC to MPX	1.28" (32.5)	2.13" (54.1)

MPC/MPX BACK-TO-BACK BODY ADAPTERS - Polysulfone



PART NO.	TYPE	A	B
MPC17C1739	MPC to MPC	0.96" (24.5)	1.81" (46.0)
MPX17X1739	MPX to MPX	1.28" (32.5)	2.44" (62.0)
MPC17X1739	MPC to MPX	1.28" (32.5)	2.13" (54.1)

PRODUCT DIMENSIONS

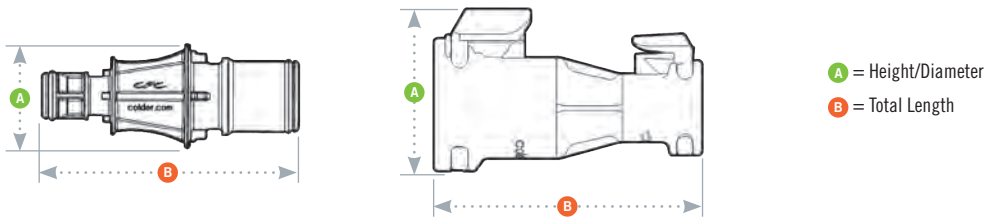

NOTES

MPC/MPX SANITARY SERIES CONNECTORS

MPC/MPX Sanitary Connectors attach directly to 3/4", 1" and 1-1/2" sanitary terminations to provide greater flexibility for integrating components into single-use or hybrid (single-use to stainless) process systems. Standard bag systems with quick couplings can be easily connected to equipment with sanitary terminations, while single-use cartridge filters can be converted to incorporate quick couplings for greater system modularity.



SPECIFICATIONS

OPERATING PRESSURE:

Vacuum to 60 psi, 4.1 bar

OPERATING TEMPERATURE:

-40°F to 300°F (-40°C to 149°C)

STERILIZATION:

- Gamma:** Up to 50 kGy irradiation
- Autoclave:** Up to 270°F (132°C) for 60 minutes, up to 25 repetitions. Sterilize uncoupled only.

TERMINATIONS:

3/4", 1" and 1-1/2" sanitary

MATERIALS:

Main components:

Polysulfone (amber tint)

Thumb Latches:

PVDF (white)

O-rings: Silicone (clear), platinum-cured

WARNING: Pressure, temperature, chemicals, and operating environment can affect the performance of couplings. It is the customer's responsibility to test the suitability of CPC's products in their own application conditions.

FEATURES

- 3/4", 1" and 1-1/2" sanitary terminations →
- Compatible with MPC and MPX Series couplings →
- Integral coupling adapters →
- ADCF-free materials →

BENEFITS

- Install to equipment with sanitary gaskets and sanitary clamps
- Quick and easy connections to industry standard plastic couplings
- Provides flexibility to easily convert sanitary terminations on filter cartridge or equipment
- Meet BSE/TSE requirements

TYPICAL FLOW RATE:

Cv Value Range: 3 - 17

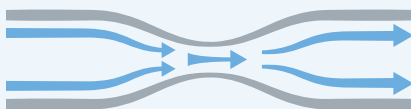

Cv values represent the approximate expected flow rate in gallons per minute of water at room temperature for a 1 PSI pressure drop. The flow is generally constrained by the smallest diameter, which in some cases will be the termination diameter and not the Nominal Flow Path.

NOTE

Validation and Extractables data can be requested on at cpcworldwide.com/Sanitary

DID YOU KNOW

MPC and MPX Sanitary connectors provide greater flexibility for filter installation.

Scan code to visit webpage



cpcworldwide.com/Sanitary

MPC/MPX SANITARY SERIES DIMENSIONS

COUPLING BODIES - Polysulfone



PART NO.	SIZE	A	B	C
MPC3301239	3/4"	0.98" (24.9)	1.40" (35.6)	1.0" (25.4)
MPX3301239	3/4"	1.28" (32.5)	1.70" (43.2)	1.0" (25.4)
MPC3301639	1"	1.50" (38.1)	1.40" (35.6)	1.50" (38.1)

COUPLING INSERTS - Polysulfone



PART NO.	SIZE	A	B
MPC44012T39M	3/4"	0.98" (24.9)	1.40" (35.6)
MPC44024T39M	1-1/2"	1.98" (50.3)	1.40" (35.6)
MPX44012T39M	3/4"	0.98" (24.9)	1.71" (43.4)
MPX44024T39M	1-1/2"	1.98" (50.3)	1.71" (43.4)

PRODUCT DIMENSIONS

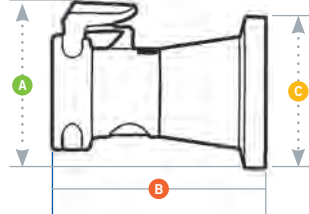
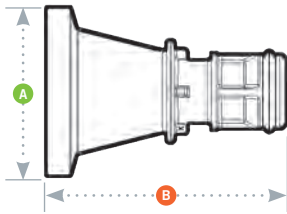

- A = Height/Diameter
- B = Total Length
- C = Sanitary Flange Diameter

NOTES

MPU SERIES CONNECTORS

MPU Connectors' twist-to-connect design

features an easy-to-use locking mechanism that guards against accidental disconnects and provide a reliable, secure connection. The 3/4" and 1" hose barb provide smooth, rapid media transfer.



SPECIFICATIONS

OPERATING PRESSURE

Vacuum to 35 psi, 2.4 bar

OPERATING TEMPERATURE

-40°F to 300°F (-40°C to 149°C)

STERILIZATION

- ☐ **Gamma:** Up to 50 kGy irradiation
- ☐ **Autoclave:** Up to 270°F (132°C), 60 minutes, up to 25 repetitions
Sterilize uncoupled only

TUBING SIZE

3/4" ID (19.0 mm), 1" ID (25.4 mm)

MATERIALS

Main components:

Polysulfone (amber tint)

O-rings:

Silicone (clear), platinum-cured

WARNING: Pressure, temperature, chemicals, and operating environment can affect the performance of couplings. It is the customer's responsibility to test the suitability of CPC's products in their own application conditions.

Scan code to visit webpage



SCAN

cpcworldwide.com/MPU

FEATURES

3/4" and 1" hose barb →

Locking feature →

Sharp barb end →

Shrouded, leak-free seal & smooth, internal flow path →

BENEFITS

Facilitates rapid fill and empty of bioprocessing bags

Guards against accidental disconnects

Minimizes fluid turbulence and dead space

Protect valuable fluids and eliminate potential to contaminate fluid path

TYPICAL FLOW RATE:

Cv Value Range: 18 - 41
for MPU

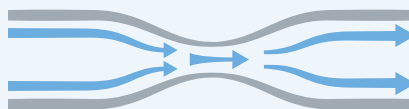

Cv values represent the approximate expected flow rate in gallons per minute of water at room temperature for a 1 PSI pressure drop. The flow is generally constrained by the smallest diameter, which in some cases will be the termination diameter and not the Nominal Flow Path.

NOTE

Validation and Extractables data can be requested at cpcworldwide.com/MPU

DID YOU KNOW

The MPU connectors are perfect for attaching to single-use mixers or single-use bioreactors when a large amount of media needs to be transferred.

MPU SERIES DIMENSIONS

COUPLING BODIES - Polysulfone



TERMINATION	METRIC EQ.	PART NO.	A	B
3/4" ID HOSE BARB	19.0 mm ID	MPU171239	1.75" (44.5 mm)	2.37" (60.2 mm)
1" ID HOSE BARB	25.4 mm ID	MPU171639	1.75" (44.5 mm)	2.37" (60.2 mm)

COUPLING INSERTS - Polysulfone



TERMINATION	METRIC EQ.	PART NO.	A	B
3/4" ID HOSE BARB	19.0 mm ID	MPU221239M	1.9" (48.3 mm)	2.88" (73.2 mm)
1" ID HOSE BARB	25.4 mm ID	MPU221639M	1.9" (48.3 mm)	2.88" (73.2 mm)

SEALING COMPONENTS - Polysulfone



SEALING CAP	MATERIAL	A	B
MPU32039	Polysulfone	1.75" (44.5mm)	.79" (20.1mm)
MPU30039M	Polysulfone	1.56" (39.6mm)	1.38" (35.1mm)

PRODUCT DIMENSIONS

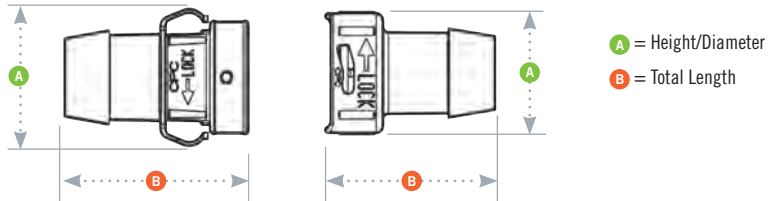

MPU ASSEMBLY PROCEDURE

STEP 1



To connect two MPU components, line up and press the two raised features on the insert (or plug) component into the notches on the body (or cap) component, then twist the two components ¼ turn until the two products latch together.

STEP 2



To disconnect two MPU components, depress the two latches on the insert (or plug) component while twisting the two separate MPU components ¼ turn to separate.





***STEAM-IN-PLACE (SIP)
TECHNOLOGY***

WHAT IS STEAM-IN-PLACE (SIP) TECHNOLOGY?

The innovative three port design of CPC's Steam-Thru® technology enables uncomplicated actuation between the SIP steam pathway and fluid transfer (flow) pathway. This provides an easy and sterile connection between flexible single-use tubing and stainless-steel processing equipment. The Steam-Thru product lines offer versatility within your process by having connection options for 3/8" and 1/2" ID tubing on the single-use side of the connector and 3/4" and 1-1/2" sanitary connections for attachment to the stainless-steel processing equipment.



FEATURES

- Innovative three-port design →
- Intuitive valve design →
- Steam-Thru II Thumb Latch →
- 3/4" and 1-1/2" Sanitary Terminations →

BENEFITS

- Allows for a true steam-through SIP process to eliminate dead legs and the need for laminar flow hoods
- Enables sterile connection/disconnection while permitting a high media flow rate
- Secures valve position, provides visual indicator of process stage

Additional features and benefits for the AseptiQuik Steam-Thru Combination:

- Genderless AseptiQuik →
- FLIP-CLICK-PULL →
- CPC Click →
- Sanitary interface between the two connectors →

- Eases single-use systems specifications with one part number for both halves
- Intuitive three-step connection process reduces risk of operator error
- Audible confirmation of assembly with no additional hardware required
- More secure connection than tubing with cable ties

NOMINAL FLOW PATH (NFP) SIZE



	NFP	CV RANGE
AQS STEAM-THRU II	(0.375")	1.0 - 2.0

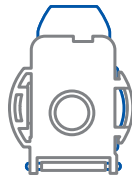

	NFP	CV RANGE
AQG STEAM-THRU II	(0.5")	3.0 - 9.0

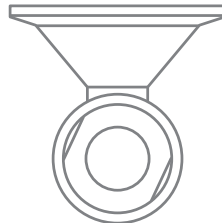

	NFP	CV RANGE
STEAM-THRU	(0.5")	4.0 - 7.0

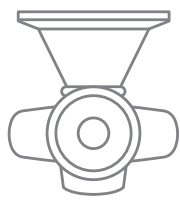

	NFP	CV RANGE
STEAM-THRU II	(0.5")	3.0 - 9.0

Cv values represent the approximate expected flow rate in gallons per minute of water at room temperature for a 1 PSI pressure drop. The flow is generally constrained by the smallest diameter, which in some cases will be the termination diameter and not the NFP.

STEAM-THRU CONNECTION OPTIONS

	SINGLE USE SYSTEM TERMINATIONS		EQUIPMENT PORT TERMINATION		CONDENSATE PORT TERMINATION		PRODUCT FEATURES			STERILIZATION OPTIONS (CHOOSE 1)		SIP	FLOW INFORMATION		
	HOSE BARB		ASEPTI-QUIK		SANITARY		SANITARY		STEAM-ON	STEAM-OFF	THUMB LATCH ACTUATION		GAMMA COMPATIBLE	AUTOCLAVEABLE	NOMINAL FLOW PATH
	3/8"	1/2"	AQS	AQG	3/4"	1-1/2"	3/4"								
STEAM-THRU	✓	✓			✓	✓	✓	✓	✓	✓	✓	✓	1/2"	4.0 – 7.0	
STEAM-THRU II	✓	✓			✓	✓	✓	✓	✓	✓	✓	✓	1/2"	3.0 – 9.0	
ASEPTIQUIK S STEAM-THRU II			✓		✓	✓	✓	✓	✓	✓	✓	✓	3/8"	1.0 – 2.0	
ASEPTIQUIK G STEAM-THRU II				✓	✓	✓	✓	✓	✓	✓	✓	✓	1/2"	3.0 – 9.0	

STEAM-THRU II ASSEMBLY PROCEDURE

STEP 1



Attach the equipment port to the stainless-steel processing equipment using a sanitary gasket and sanitary tri-clamp.

STEP 2



Attach the steam condensate line to the steam condensate port using a sanitary gasket and tri-clamp.

STEP 3

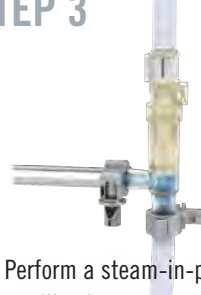

Perform a steam-in-place sterilization per your validated parameters and allow the connector to cool to room temperature.

STEP 4

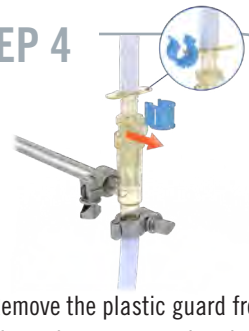

Remove the plastic guard from above the connector thumb latch and transfer it to one of the tabs located directly above it.

STEP 5



With the guard removed you can now press the thumb latch and actuate the connector from the steam position to the flow position.

STEP 6



Perform fluid transfer through the connector.

STEP 7



Press the thumb latch and actuate the connector from the flow position to the steam position, and return the guard to its original position.

STEP 8



Perform a second steam-in-place cycle to "steam off" the connection.

STEAM-THRU® SERIES CONNECTORS

Steam-Thru® Connectors allow a quick and easy sterile connection between stainless steel biopharmaceutical processing equipment and disposable bag and tube assemblies. The single-use design saves time and money by eliminating unnecessary cleaning procedures and reducing validation burden associated with reusable components.

SPECIFICATIONS

OPERATING CONDITIONS

(Fluid Transfer)

STEAM POSITION

Temperature:

39°F to 104°F (4°C to 40°C)

Pressure:

Up to 30 psi, 2.1 bar (Steam-Thru)

Up to 35 psi, 2.4 bar (Steam-Thru II)

FLOW POSITION

Temperature: 39°F to 104°F (4°C to 40°C)

Pressure: Vacuum to 20 psi, 1.4 bar

STERILIZATION

Full Connector Assembly

Gamma: Up to 50 kGy irradiation

Autoclave: Up to 265°F (129°C)

for 60 minutes

Steam-In-Place (SIP):

Up to 266°F/130°C (up to ~24psi),

60 minutes (Steam-Thru)

Up to 275°F/135°C (up to ~31psi),

60 minutes (Steam-Thru II)

TERMINATIONS

3/8" (9.5mm) to 1/2" (12.7mm) ID hose barb
(Steam-Thru)

3/8" (9.5mm) to 1/2" (12.7mm) ID hose barb
and 3/4" sanitary (Steam-Thru II)

MATERIALS

Connection: Polysulfone (amber tint)

O-rings: Silicone (clear), platinum-cured

Removeable Sleeve: Polycarbonate

NOTE: Steam pressures are estimated based upon information in Steam Tables found in literature



FEATURES

Innovative three-port design →

Valve design →

Steam-Thru II thumb latch →

3/4" and 1-1/2" sanitary terminations →

BENEFITS

Allows a true steam-through SIP process which eliminates "dead legs" and the need for laminar flow hoods

Allows sterile connection and disconnection and permits high media flow rate

Secures valve position, provides visual indicator of process stage

Easily connects to process equipment

TYPICAL FLOW RATE:

Cv Value Range:

4.0 - 7.0 for Steam-Thru

3.0 - 9.0 for Steam-Thru II

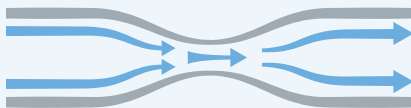

Cv values represent the approximate expected flow rate in gallons per minute of water at room temperature for a 1 PSI pressure drop. The flow is generally constrained by the smallest diameter, which in some cases will be the termination diameter and not the Nominal Flow Path.

Scan code to visit webpage



SCAN

cpcworldwide.com/STC

NOTE

Validation and Extractables data can be requested at cpcworldwide.com/STC

DID YOU KNOW

Steam-Thru connectors are perfect for any hybrid processing at your facility. If using a stainless-steel bioreactor and single-use systems, easily make a sterile connection between the two systems with a Steam-Thru connector on your single-use system and mounting it directly onto your bioreactor.

STEAM-THRU SERIES DIMENSIONS

POLYSULFONE with polycarbonate sleeve



TERMINATION	PART NO.	A	B	C	D	E
3/4" X 3/4" SANITARY X 1/2" HB	STC1700000	1.20" (30.5 mm)	5.09" (129.3 mm)	4.44" (112.8 mm)	2.00" (50.8 mm)	0.89" (22.6 mm)
3/4" X 3/4" SANITARY X 3/8" HB	STC1700100	1.20" (30.5 mm)	4.80" (121.9 mm)	4.15" (105.4 mm)	2.00" (50.8 mm)	0.60" (15.2 mm)
3/4" X 1-1/2" SANITARY X 1/2" HB	STC1700200	1.20" (30.5 mm)	5.09" (129.3 mm)	4.44" (112.8 mm)	2.00" (50.8 mm)	0.89" (22.6 mm)
3/4" X 1-1/2" SANITARY X 3/8" HB	STC1700300	1.20" (30.5 mm)	4.80" (121.9 mm)	4.15" (105.4 mm)	2.00" (50.8 mm)	0.60" (15.2 mm)

STEAM-THRU CONFIGURATIONS

Steam-Thru Connection's three-port design allows steam to pass directly through the lower ports to "steam on" to stainless equipment. After the SIP cycle is completed, the connector's valve is actuated, creating a sterile flow path to single-use systems.

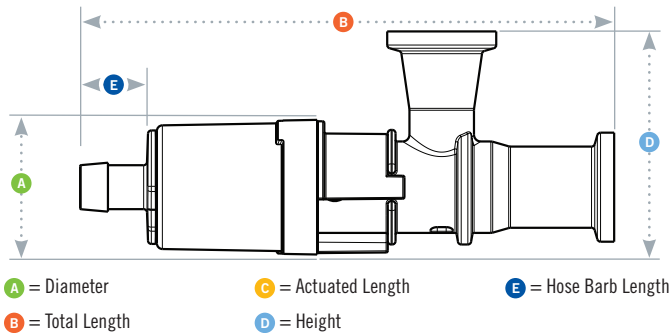

STEAM-THRU II SERIES DIMENSIONS

POLYSULFONE with polycarbonate sleeve



TERMINATION	PART NO.	A	B	C	D	E
3/4" X 3/4" SANITARY X 1/2" HB	STC2020000	1.42" (36.1 mm)	6.84" (173.7 mm)	5.93" (150.6 mm)	2.40" (61.0 mm)	0.88" (22.4 mm)
3/4" X 3/4" SANITARY X 3/8" HB	STC2020100	1.42" (36.1 mm)	6.76" (171.7 mm)	5.93" (150.6 mm)	2.40" (61.0 mm)	0.80" (20.3 mm)
3/4" X 1-1/2" SANITARY X 1/2" HB	STC2020200	1.42" (36.1 mm)	6.84" (173.7 mm)	5.93" (150.6 mm)	2.40" (61.0 mm)	0.88" (22.4 mm)
3/4" X 1-1/2" SANITARY X 3/8" HB	STC2020300	1.42" (36.1 mm)	6.76" (171.7 mm)	5.93" (150.6 mm)	2.40" (61.0 mm)	0.80" (20.3 mm)
3/4" X 3/4" SANITARY X 3/4" SANITARY	STC2020900	1.42" (36.1 mm)	6.60" (167.6 mm)	5.93" (150.6 mm)	2.40" (61.0 mm)	0.62" (15.7 mm)
3/4" X 1-1/2" SANITARY X 3/4" SANITARY	STC2021000	1.42" (36.1 mm)	6.60" (167.6 mm)	5.93" (150.6 mm)	2.40" (61.0 mm)	0.62" (15.7 mm)

All measurements are in inches (millimeters) unless otherwise noted. Tubing must meet stated inside and outside diameters.

STEAM-THRU II CONFIGURATIONS

Steam-Thru II Connections offer the flexibility of "steam on" and "steam off" functionality. The innovative design allows the valve to be returned to the steam position enabling a second SIP cycle following media transfer. The "steam off" disconnection of single-use systems minimizes cross-contamination risks associated with reusable components.

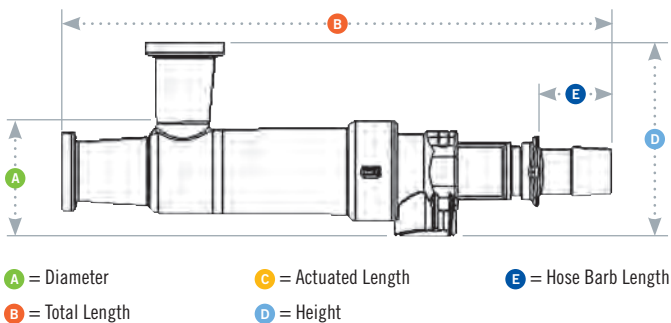

ASEPTIQUIK® STC II SERIES CONNECTORS

AseptiQuik® STC Connectors combine the AseptiQuik® sterile connector and the Steam-Thru® II SIP connector, giving manufacturers greater flexibility between hybrid stainless steel and single-use processing equipment.

The union of the two connectors into a single unit through a sanitary clamp allows an AseptiQuik sterile connection to be steamed on to stainless equipment via SIP. After the SIP cycle, a wide range of single-use systems can be connected.



SPECIFICATIONS

OPERATING CONDITIONS

(Fluid Transfer)

Steam Position:

Temperature: Up to 275°F (135°C) for 60 minutes

PRESSURE

Up to 35 psi, 2.4 bar

Flow Position:

Temperature: 39°F to 104°F (4°C to 40°C)

Pressure: Up to 20 psi, 1.4 bar

STERILIZATION

Full Connector Assembly:

Gamma: Up to 50 kGy irradiation

Autoclave: High Temp (HT) Version
Up to 266°F (130°C) for 60 minutes
(AQQSTC)

Steam-In-Place (SIP):

Up to 275°F (135°C) (~31 psi) for 60 minutes

TERMINATIONS

3/8" (9.5mm) to 1/2" (12.7mm) ID hose barb
(Steam-Thru)

3/8" (9.5mm) to 1/2" (12.7mm) ID hose barb
and 3/4" sanitary (Steam-Thru II)

MATERIALS:

Main Components:

AseptiQuik - Polycarbonate (white)

Steam-Thru II - Polysulfone (amber tint)

Seals: Silicone (clear), platinum-cured

Removable Sleeve: Polycarbonate (white)

Pull Tabs:

Polycarbonate (blue, standard version)

Polycarbonate (white, HT version)

Membrane:

Polyethylene (standard version)

Hydrophobic polyethersulfone (HT versions),

PTFE strip sticker

Clamp: Nylon 66 (white)

NOTE: Steam pressures are estimated based upon information in Steam Tables found in literature

Scan code to visit webpage



SCAN

cpcworldwide.com/AseptiQuik-STC

TYPICAL FLOW RATE:

Cv Value Range:

1 - 2 for AQSSTCII

3 - 9 for AQQSTCII

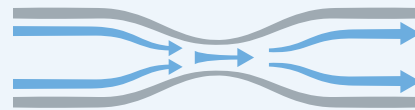

Cv values represent the approximate expected flow rate in gallons per minute of water at room temperature for a 1 PSI pressure drop. The flow is generally constrained by the smallest diameter, which in some cases will be the termination diameter and not the Nominal Flow Path.

NOTE

Validation and Extractables data can be requested at cpcworldwide.com/AseptiQuik-STC

DID YOU KNOW

The AQSSTC provides the same sterile hybrid technology as the Steam-Thru II, but in an even more compact form. The AQSSTC has an AseptiQuik mounted on the single-use port of the Steam-Thru Connector. Meaning fewer single-use systems mounted on your bioreactor during the SIP process. Connect the other end of the AQS at any point after the SIP process and before actuating to the flow position.

ASEPTIQUIK STC SERIES DIMENSIONS

COMBINATION PRODUCT - Polycarbonate with blue pull tabs and Steam-Thru II- *For gamma irradiation applications.*



TERMINATION	PART NO.	A	B	C
3/4" X 3/4" SANITARY STEAM-THRU II WITH ASEPTIQUIK G BODY	AQGSTC2330900	3.05" (77.5 mm)	8.26" (209.8 mm)	7.36" (186.9 mm)
3/4" X 1-1/2" SANITARY STEAM-THRU II WITH ASEPTIQUIK G BODY	AQGSTC2331000	3.05" (77.5 mm)	8.26" (209.8 mm)	7.36" (186.9 mm)
3/4" X 3/4" SANITARY STEAM-THRU II WITH ASEPTIQUIK S BODY	AQSSTC2330900	2.45" (62.2 mm)	8.20" (208.2 mm)	7.30" (185.4 mm)
3/4" X 1-1/2" SANITARY STEAM-THRU II WITH ASEPTIQUIK S BODY	AQSSTC2331000	2.45" (62.2 mm)	8.20" (208.2 mm)	7.30" (185.4 mm)

COMBINATION PRODUCT - Polycarbonate HT with white pull tabs and Steam-Thru II- *For autoclave or gamma irradiation applications.*



TERMINATION	PART NO.	A	B	C
3/4" X 3/4" SANITARY STEAM-THRU II WITH ASEPTIQUIK G BODY	AQGSTC2330900HT	3.05" (77.5 mm)	8.26" (209.8 mm)	7.36" (186.9 mm)
3/4" X 1-1/2" SANITARY STEAM-THRU II WITH ASEPTIQUIK G BODY	AQGSTC2331000HT	3.05" (77.5 mm)	8.26" (209.8 mm)	7.36" (186.9 mm)
3/4" X 3/4" SANITARY STEAM-THRU II WITH ASEPTIQUIK S BODY	AQSSTC2330900HT	2.45" (62.2 mm)	8.20" (208.2 mm)	7.30" (185.4 mm)
3/4" X 1-1/2" SANITARY STEAM-THRU II WITH ASEPTIQUIK S BODY	AQSSTC2331000HT	2.45" (62.2 mm)	8.20" (208.2 mm)	7.30" (185.4 mm)

PRODUCT DIMENSIONS

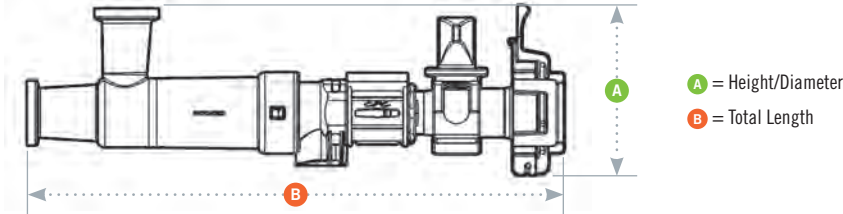

FEATURES

- Genderless AseptiQuik → Eases single-use systems specifications with one-part number for both halves
- FLIP-CLICK-PULL → Intuitive three-step connection process reduces risk of operator error
- CPC Click → Audible confirmation of assembly with no additional hardware required
- Innovative three-port steam design → Allows a true steam-through SIP process which eliminates "dead legs"
- Steam valve design → Allows sterile connection and disconnection to stainless equipment and permits a high media flow rate
- Sanitary interface between the two connectors → More secure connection than tubing with cable ties

BENEFITS

PRODUCT INDEX

ASEPTIC CONNECTION

TECHNOLOGY10-23

- MICROCNX® Series Connectors 12
- ASEPTIQUIK® S Series Connectors 16
- ASEPTIQUIK® G Series Connectors 18
- ASEPTIQUIK® L Series Connectors 20
- ASEPTIQUIK® W Series Connectors 22

STERILE DISCONNECTION

TECHNOLOGY24-29

- HFC Disconnect Series Connectors 28

ASEPTIC COMBINATION

CONNECTORS30-35

- ASEPTIQUIK® G DC Series Connectors . . . 34

OPEN FORMAT CONNECTION

TECHNOLOGY36-49

- MPC Series Connectors 40
- MPX Series Connectors 42
- MPC/MPX Back-to-Back Series Adapters 44
- MPC/MPX Sanitary Series Connectors . . 46
- MPU Series Connectors 48

STEAM-IN-PLACE CONNECTION

TECHNOLOGY50-57

- STEAM-THRU® Series Connectors 54
- ASEPTIQUIK® STC Series Connectors . . . 56





Colder Products Company®

COLDER PRODUCTS COMPANY
2820 CLEVELAND AVE. N.,
ROSEVILLE, MINNESOTA 55113
U.S.A.

PHONE: +1 (651) 645-0091
FAX: +1 (651) 645-5404
TOLL FREE: +1 (800) 519-7633

COLDER PRODUCTS COMPANY GMBH
KURHESSENSTRASSE 15
64546 MÖRFELDEN-WALLDORF
GERMANY

PHONE: +49 6105 9743-003

DOVER (SHANGHAI) INDUSTRIAL CO., LTD.
ROOM 1802, BUILDING A, IBC,
391 GUIPING ROAD, XUHUI DISTRICT,
SHANGHAI, CHINA 200233

PHONE: +86 21 2411 2666
TOLL FREE: +86 400 990 1978

cpcworldwide.com/bio
info@cpcworldwide.com

CPC WARRANTY STATEMENT: CPC (Colder Products Company) warrants its products against defects in workmanship and materials for a period of 12 months from the date of sale by CPC to its initial customer (regardless of any subsequent sale of the products). This warranty is void if the product is misused, altered, tampered with or is installed or used in a manner that is inconsistent with CPC's written recommendations, specifications and/or instructions, or fails to perform due to normal wear and tear. CPC does not warrant the suitability of the product for any particular application. Determining product application suitability is solely the customer's responsibility. CPC is not liable for special, indirect, incidental, consequential or other damages including, but not limited to, loss, damage, personal injury, or any other expense directly or indirectly arising from the use of or inability to use its products either separately or in combination with other products. **ALL OTHER WARRANTIES EXPRESS OR IMPLIED, WHETHER ORAL, WRITTEN OR IN ANY OTHER FORM, INCLUDING BUT NOT LIMITED TO WARRANTIES OF MERCHANTABILITY OR FITNESS FOR A PARTICULAR PURPOSE, ARE EXPRESSLY EXCLUDED.** The sole and exclusive remedy under this warranty is limited, at the option of CPC, to replacement of the defective product or an account credit in the amount of the original selling price. All allegedly defective CPC products must be returned prepaid transportation to CPC, together with information describing the product's application and performance, unless otherwise authorized in writing by CPC.

CPC PATENT STATEMENT: CPC takes pride in its innovative quick disconnect coupling and fittings solutions, many of which have been awarded United States and international patents. CPC has a strong tradition of leadership in the quick disconnect market, and aggressively pursues and protects its proprietary information and intellectual property. In cases where it is practical and has a benefit to its customers, CPC has licensed its proprietary technology. Please contact CPC to discuss your unique needs.

CPC TRADEMARK STATEMENT: AseptiQuik®, BottleQuik®, BreakAway®, ChemQuik®, DrumQuik®, FitQuik®, IdentiQuik®, Nu-Seal®, SnapQuik®, Steam-Thru®, Softube® are registered trademarks with the U.S. Patent & Trademark Office. All other trademarks or service marks are property of their respective owners. **WARNING:** Due to the wide variety of possible fluid media and operating conditions, unintended consequences may result from the use of this product, all of which are beyond the control of CPC. It is the user's responsibility to carefully determine and test for compatibility for use with their application. All such risks shall be assumed by the buyer.

COPYRIGHT © 2023 COLDER PRODUCTS COMPANY. All rights reserved. Colder Products Company, Colder Products and CPC are registered trademarks with the US Patent & Trademark Office.

WARNING: Due to the wide variety of possible fluid media and operating conditions, unintended consequences may result from the use of this product, all of which are beyond the control of CPC. It is the user's responsibility to carefully determine and test for compatibility for use with their application. All such risks shall be assumed by the buyer.